



# ODKVAPOVÝ SYSTÉM POLKRUHOVÝ



**CENNÍK**  
2022



POWERFUL PARTNER FOR YOUR ROOF



Pozinkovaný  
materiál | 3



Žraby | 6



Dilatácie | 12



Žraby  
príslušenstvo | 15



Háky | 19



Rohy | 24



Čelá | 26



Kotlíky | 28



Kolená | 40



Zvodové  
rúry | 45



Zvodové rúry  
príslušenstvo | 52



Objímky | 55



Objímky  
príslušenstvo | 59



Zachytávače  
vody | 62



Ochranné  
zvodové rúry | 65

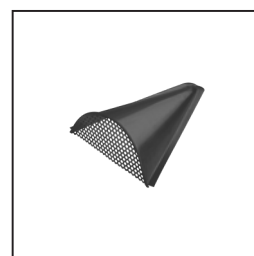

Strešné  
doplňky | 68



Klmpiarske  
nástroje | 69



Strešná  
chémia | 69

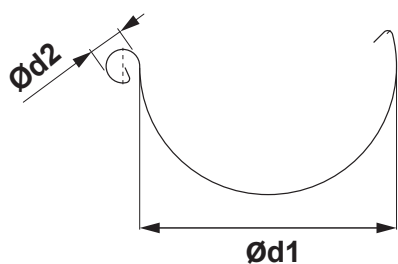

## ROZMERY STREŠNÝCH ŽLABOV

(rozmery a rozmerové tolerancie podľa EN 612)

Rozvinutá šírka (mm)	200	250	280	333	400	500
Ød1	80	105	127	153	192	250
Ød2	16	18	18	20	22	22

## VNÚTORNÝ FALZ

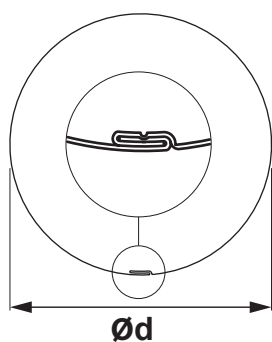

## ROZMERY STREŠNÝCH ZVODOV

(rozmery a rozmerové tolerancie podľa EN 612)

Rozmery	60	80	100	120	150
Menovitá veľkosť Ød (mm)	60	80	100	120	150

## ROZMERY STREŠNÝCH HÁKOV

(rozmery a rozmerové tolerancie podľa EN 612)

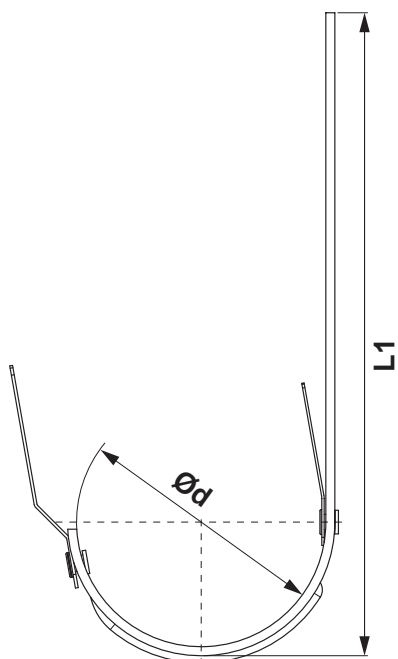

Rozmery (mm)	L1	Ød
200	290	80
250	310	105
280	345	127
333 – 510	345	153
333 – 550	385	153
333 – 610	445	153
400	400	192

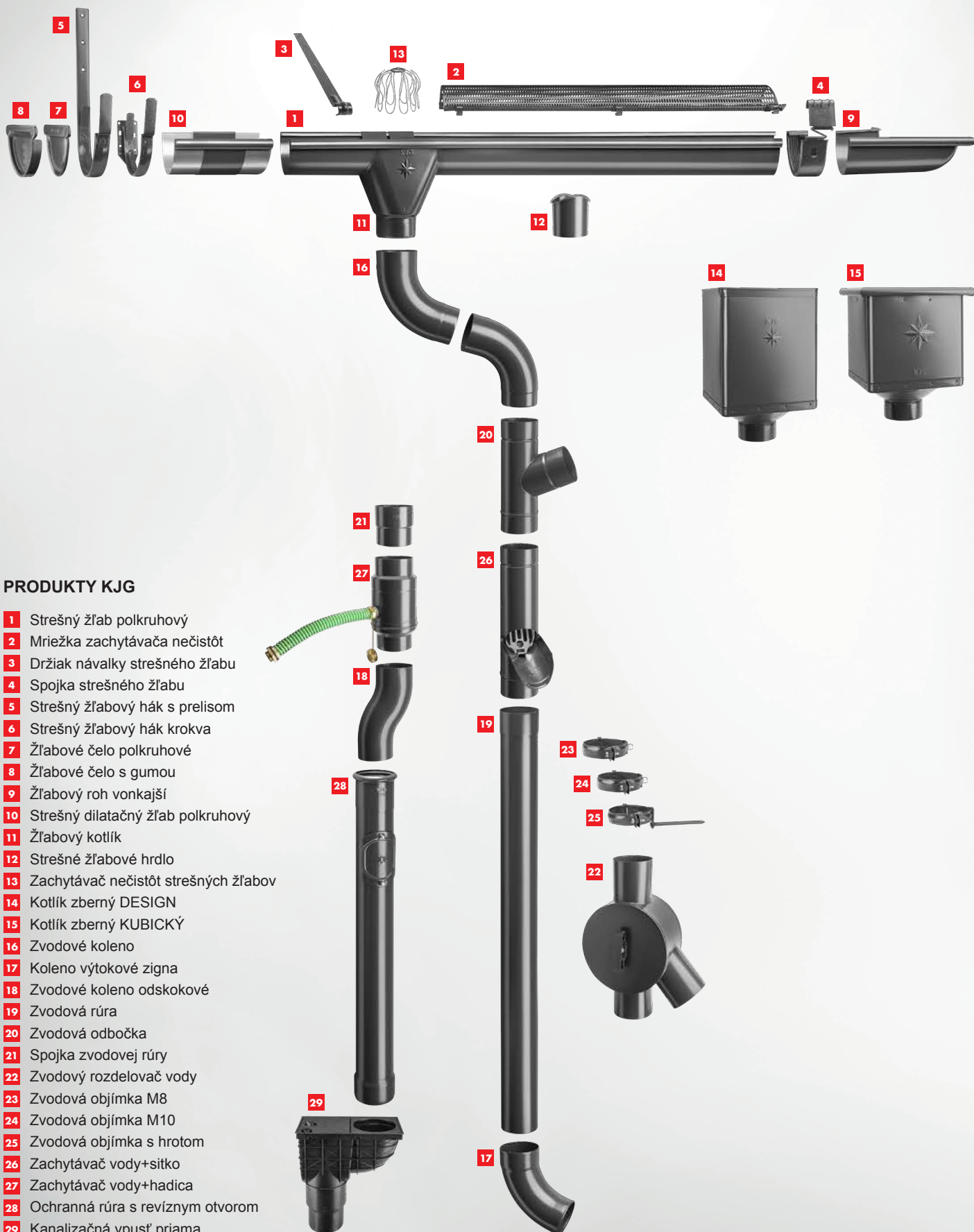

## PRODUKTY KJG

- 1 Strešný žlab polkruhový
- 2 Mriežka zachytávača nečistôt
- 3 Držiak návalky strešného žlabu
- 4 Spojka strešného žlabu
- 5 Strešný žlabový hák s prelisom
- 6 Strešný žlabový hák krokva
- 7 Žlabové čelo polkruhové
- 8 Žlabové čelo s gumou
- 9 Žlabový roh vonkajší
- 10 Strešný dilatačný žlab polkruhový
- 11 Žlabový kotlík
- 12 Strešné žlabové hrdlo
- 13 Zachytávač nečistôt strešných žlabov
- 14 Kotlík zberný DESIGN
- 15 Kotlík zberný KUBICKÝ
- 16 Zvodové koleno
- 17 Koleno výtokové zigna
- 18 Zvodové koleno odskokové
- 19 Zvodová rúra
- 20 Zvodová odbočka
- 21 Spojka zvodovej rúry
- 22 Zvodový rozdelovač vody
- 23 Zvodová objímka M8
- 24 Zvodová objímka M10
- 25 Zvodová objímka s hrotom
- 26 Zachytávač vody+sitko
- 27 Zachytávač vody+hadica
- 28 Ochranná rúra s revíznym otvorom
- 29 Kanalizačná vpusť priama

## TATA STEEL

Spoločnosť Tata bola založená v roku 1868 spoločnosťou Jamsetji Nusserwanji Tata a sídlom v Indii. Je globálnym obchodným konglomerátom, ktorý pôsobí vo viac ako 100 krajinách na piatich kontinentoch. Od skorého nástupu do ocele a automobilov, aby sa držal krok s najnovšími technológiami, má dnes skupina Tata silnú pozíciu v rôznych odvetviach, ako sú agrochemikálie, automobilový priemysel, chemikálie, stavebníctvo, financie a spotrebné výrobky.



## MARCEGAGLIA

Marcegaglia je vedúci hráč v Taliansku a najväčší nezávislý globálny operátor v oceliarskom priemysle. S každým rokom spracovaným 5,6 milióna ton a s obratom viac ako 5 miliárd eur (2017), je Marcegaglia talianskou priemyselnou skupinou, ktorá je popredným hráčom v Európe a na celom svete v transformácii ocele. Získané vedenie je výsledkom dlhej, pevnej a stabilnej rastovej cesty, ktorá robí Marcegaglia najväčším nezávislým globálnym hráčom v transformácii ocele.

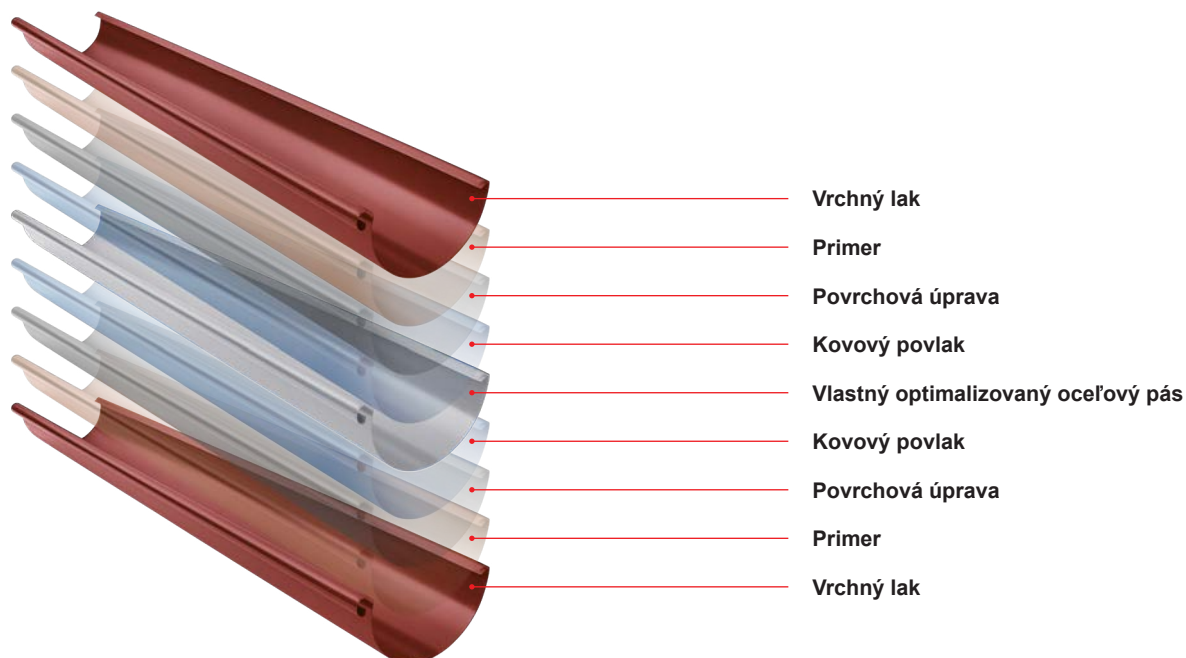

## STREŠNÝ ŽĽAB POLKRUHOVÝ [s=0,55]

P-PZ

Menovitá veľkosť	200		200		200	
	2,0		3,0		4,0	
Dĺžka v m						
Cena v €/m	Bez DPH	S DPH	Bez DPH	S DPH	Bez DPH	S DPH
<b>TM</b> 1 Testa di Moro RAL 8028	7,70	9,24	7,70	9,24	7,70	9,24
	043610		043627		043634	
<b>AN</b> 2 Antracit RAL 7016	7,70	9,24	7,70	9,24	7,70	9,24
	042187		042194		042200	
<b>IC</b> 3 Intenzívna čierna RAL 9005	7,70	9,24	7,70	9,24	7,70	9,24
	042545		042552		042569	
<b>OC</b> 4 Oceľovo červená RAL 3009			7,70	9,24	7,70	9,24
			043191		043207	
<b>MH</b> 5 Medeno hnedá RAL 8004			7,80	9,36		
			042750			
<b>SB</b> 6 Šedo biela RAL 9002			7,80	9,36		
			043498			
<b>BH</b> 7 Bielo hliníková RAL 9006			7,80	9,36	7,80	9,36
			042392		042408	
<b>PS</b> 8 Prachovo šedá RAL 7037			7,80	9,36	7,80	9,36
			043375		043382	
<b>MM</b> 9 Metalická medená RAL extra			8,30	9,96		
			042927			
<b>BHT – P.20</b> 10 Bielo hliníková tmavá RAL 9007						
<b>MZ</b> 11 Machovo zelená RAL 6005			8,30	9,96		
			043085			
<b>MOT</b> 12 Tmavo modrá RAL 5010			8,30	9,96		
			043016 *			
<b>TZ</b> 13 Trávovo zelená RAL 6011			8,30	9,96		
			043825 *			
<b>Balenie v m</b> 			15			
<b>Balenie v m</b> 	800		1 200		1 600	

\* Výroba na objednávku



## STREŠNÝ ŽLAB POLKRUHOVÝ [s=0,55]

P-PZ

Menovitá veľkosť	250		250		250		250		250	
	2,0		3,0		4,0		5,0		6,0	
Dĺžka v m	2,0		3,0		4,0		5,0		6,0	
Cena v €/m	Bez DPH	S DPH	Bez DPH	S DPH	Bez DPH	S DPH	Bez DPH	S DPH	Bez DPH	S DPH
<b>TM</b> 1 Testa di Moro RAL 8028	6,90	8,28	6,70	8,04	6,70	8,04	6,70	8,04	6,70	8,04
	043641		043658		043665		043672		043689	
<b>AN</b> 2 Antracit RAL 7016	6,90	8,28	6,70	8,04	6,70	8,04	6,70	8,04	6,70	8,04
	042217		042224		042231		042248		042255	
<b>IC</b> 3 Intenzívna čierna RAL 9005	6,90	8,28	6,70	8,04	6,70	8,04	6,70	8,04	6,70	8,04
	042576		042583		042590		042606		042613	
<b>OC</b> 4 Oceľovo červená RAL 3009	6,90	8,28	6,70	8,04	6,70	8,04	6,70	8,04	6,70	8,04
	043214		043221		043238		043245		043252	
<b>MH</b> 5 Medeno hnedá RAL 8004	7,00	8,40	6,80	8,16	6,80	8,16	6,80	8,16	6,80	8,16
	042774		042781		042798		042804		042811	
<b>SB</b> 6 Šedo biela RAL 9002			6,80	8,16	6,80	8,16			6,80	8,16
			043504		043511				043528	
<b>BH</b> 7 Bielo hliníková RAL 9006			6,80	8,16	6,80	8,16	6,80	8,16	6,80	8,16
			042415		042422		042439		042446	
<b>PS</b> 8 Prachovo šedá RAL 7037					6,80	8,16			6,80	8,16
					043399				043405	
<b>MM</b> 9 Metalická medená RAL extra					7,20	8,64			7,20	8,64
					042934				042941	
<b>BHT – P.20</b> 10 Bielo hliníková tmavá RAL 9007					8,30	9,96				
					095466					
<b>MZ</b> 11 Machovo zelená RAL 6005					7,20	8,64			7,20	8,64
					043092				043108	
<b>MOT</b> 12 Tmavo modrá RAL 5010					7,20	8,64				
					043023					
<b>TZ</b> 13 Trávovo zelená RAL 6011					7,20	8,64				
					043832					
<b>Balenie v m</b> 📦										
<b>Balenie v m</b> 🚚	480		720		960		1 200		1 440	



**STREŠNÝ ŽĽAB POLKRUHOVÝ [s=0,55]**
**P-PZ**

Menovitá veľkosť	280		280		280		280		280	
	2,0		3,0		4,0		5,0		6,0	
Dĺžka v m										
Cena v €/m	Bez DPH	S DPH	Bez DPH	S DPH	Bez DPH	S DPH	Bez DPH	S DPH	Bez DPH	S DPH
	<b>TM</b> 1 Testa di Moro RAL 8028	7,80	9,36	7,60	9,12	7,60	9,12	7,60	9,12	7,60
043696		043702		043719		043726		043733		
<b>AN</b> 2 Antracit RAL 7016	7,80	9,36	7,60	9,12	7,60	9,12	7,60	9,12	7,60	9,12
	042262		042279		042286		042293		042309	
<b>IC</b> 3 Intenzívna čierna RAL 9005	7,80	9,36	7,60	9,12	7,60	9,12	7,60	9,12	7,60	9,12
	042620		042637		042644		042651		042668	
<b>OC</b> 4 Oceľovo červená RAL 3009			7,60	9,12	7,60	9,12	7,60	9,12	7,60	9,12
			043269		043276		043283		043290	
<b>MH</b> 5 Medeno hnedá RAL 8004			7,70	9,24	7,70	9,24			7,70	9,24
			042828		042835				042842	
<b>SB</b> 6 Šedo biela RAL 9002					7,70	9,24			7,70	9,24
					043535				043542	
<b>BH</b> 7 Bielo hliníková RAL 9006			7,70	9,24	7,70	9,24			7,70	9,24
			042453		042460				042477	
<b>PS</b> 8 Prachovo šedá RAL 7037					7,70	9,24			7,70	9,24
					043412				043429	
<b>MM</b> 9 Metalická medená RAL extra					8,25	9,90			8,25	9,90
					042958				042965	
<b>BHT – P.20</b> 10 Bielo hliníková tmavá RAL 9007					9,30	11,16				
					095473					
<b>MZ</b> 11 Machovo zelená RAL 6005					8,25	9,90			8,25	9,90
					043115				043122	
<b>MOT</b> 12 Tmavo modrá RAL 5010					8,25	9,90				
					043030					
<b>TZ</b> 13 Trávovo zelená RAL 6011					8,25	9,90				
					043849					
<b>Balenie v m</b> 📦					20		25			
<b>Balenie v m</b> 🚚	420		630		840		1 050		1 260	

**POZINK**  
 POLYESTER



## STREŠNÝ ŽLAB POLKRUHOVÝ [s=0,55]

P-PZ

Menovitá veľkosť	333		333		333		333		333		
	2,0		3,0		4,0		5,0		6,0		
Dĺžka v m	2,0		3,0		4,0		5,0		6,0		
	Bez DPH	S DPH	Bez DPH	S DPH	Bez DPH	S DPH	Bez DPH	S DPH	Bez DPH	S DPH	
<b>TM</b> Testa di Moro RAL 8028	1	8,10	9,72	7,90	9,48	7,90	9,48	7,90	9,48	7,90	9,48
		043740		043757		043764		043771		043788	
<b>AN</b> Antracit RAL 7016	2	8,10	9,72	7,90	9,48	7,90	9,48	7,90	9,48	7,90	9,48
		042316		042323		042330		042347		042354	
<b>IC</b> Intenzívna čierna RAL 9005	3	8,10	9,72	7,90	9,48	7,90	9,48	7,90	9,48	7,90	9,48
		042675		042682		042699		042705		042712	
<b>OC</b> Oceľovo červená RAL 3009	4	8,10	9,72	7,90	9,48	7,90	9,48	7,90	9,48	7,90	9,48
		043306		043313		043320		043337		043344	
<b>MH</b> Medeno hnedá RAL 8004	5	8,20	9,84	8,00	9,60	8,00	9,60	8,00	9,60	8,00	9,60
		042859		042866		042873		042880		042897	
<b>SB</b> Šedo biela RAL 9002	6			8,00	9,60	8,00	9,60	8,00	9,60	8,00	9,60
				043559		043566		043573		043580	
<b>BH</b> Bielo hliníková RAL 9006	7			8,00	9,60	8,00	9,60	8,00	9,60	8,00	9,60
				042484		042491		042507		042514	
<b>PS</b> Prachovo šedá RAL 7037	8			8,00	9,60	8,00	9,60	8,00	9,60	8,00	9,60
				043436		043443		043450		043467	
<b>MM</b> Metalická medená RAL extra	9					9,20	11,04	9,20	11,04	9,20	11,04
						042972		042989		042996	
<b>BHT – P.20</b> Bielo hliníková tmavá RAL 9007	10					9,40	11,28			9,40	11,28
						095480				095497	
<b>MZ</b> Machovo zelená RAL 6005	11					9,20	11,04	9,20	11,04	9,20	11,04
						043139		043146		043153	
<b>MOT</b> Tmavo modrá RAL 5010	12					9,20	11,04			9,20	11,04
						043047				043054	
<b>TZ</b> Trávovo zelená RAL 6011	13					9,20	11,04				
						043856					
<b>Balenie v m</b> 📦		10				20		25		30	
<b>Balenie v m</b> 🚚		330		495		660		825		990	



## STREŠNÝ ŽLAB POLKRUHOVÝ [s=0,55]

P-PZ

Menovitá veľkosť	400		400		500		500		333	
	4,0		6,0		4,0		6,0		7,0	
Dĺžka v m	4,0		6,0		4,0		6,0		7,0	
Cena v €/m	Bez DPH	S DPH	Bez DPH	S DPH	Bez DPH	S DPH	Bez DPH	S DPH	Bez DPH	S DPH
<b>TM</b> Testa di Moro RAL 8028	12,70	15,24	12,70	15,24					7,90	9,48
	043801		043818						043795 *	
<b>AN</b> Antracit RAL 7016	12,70	15,24	12,70	15,24	17,20	20,64	17,20	20,64		
	042361		042378		086730 *		086747 *			
<b>IC</b> Intenzívna čierna RAL 9005	12,70	15,24	12,70	15,24						
	042729		042736							
<b>OC</b> Oceľovo červená RAL 3009	12,70	15,24	12,70	15,24						
	043351		043368							
<b>MH</b> Medeno hnedá RAL 8004	12,80	15,36	12,80	15,36						
	042903		042910							
<b>SB</b> Šedo biela RAL 9002	12,80	15,36	12,80	15,36	17,30	20,76	17,30	20,76		
	043597		043603		086778 *		086785 *			
<b>BH</b> Bielo hliníková RAL 9006	12,80	15,36	12,80	15,36	17,30	20,76	17,30	20,76		
	042521		042538		086754 *		086761 *			
<b>PS</b> Prachovo šedá RAL 7037	12,80	15,36	12,80	15,36						
	043474		043481							
<b>MM</b> Metalická medená RAL extra	13,50	16,20								
	043009									
<b>BHT – P.20</b> Bielo hliníková tmavá RAL 9007			14,20	17,04						
			095503							
<b>MZ</b> Machovo zelená RAL 6005	13,50	16,20	13,50	16,20						
	043160		043177 *							
<b>MOT</b> Tmavo modrá RAL 5010	13,50	16,20	13,50	16,20						
	043061		043078							
<b>TZ</b> Trávovo zelená RAL 6011	13,50	16,20								
	043863 *									
<b>Balenie v m</b> 📦	20		30						35	
<b>Balenie v m</b> 🚛	540		810		-		-		1 155	

\* Výroba na objednávku



### NÁSTREŠNÝ ŽLAB SAMRÍNOVÝ [s=0,55]

**P-PZS**

Menovitá veľkosť	650		650	
	4,0		6,0	
Dĺžka v m	4,0		6,0	
Cena v €/m	Bez DPH	S DPH	Bez DPH	S DPH
<b>TM</b> 1 Testa di Moro RAL 8028	24,50	<b>29,40</b>	24,50	<b>29,40</b>
	049926		049933	
<b>AN</b> 2 Antracit RAL 7016	24,50	<b>29,40</b>	24,50	<b>29,40</b>
	049759		049766	
<b>IC</b> 3 Intenzívna čierna RAL 9005	24,50	<b>29,40</b>	24,50	<b>29,40</b>
	049797		049803	
<b>OC</b> 4 Oceľovo červená RAL 3009	24,50	<b>29,40</b>	24,50	<b>29,40</b>
	049865		049872	
<b>MH</b> 5 Medeno hnedá RAL 8004	25,50	<b>30,60</b>	25,50	<b>30,60</b>
	049810		049827	
<b>SB</b> 6 Šedo biela RAL 9002	25,50	<b>30,60</b>	25,50	<b>30,60</b>
	049902		049919	
<b>BH</b> 7 Bielo hliníková RAL 9006	25,50	<b>30,60</b>	25,50	<b>30,60</b>
	049773		049780	
<b>PS</b> 8 Prachovo šedá RAL 7037	25,50	<b>30,60</b>		
	049889			
<b>MM</b> 9 Metalická medená RAL extra	28,00	<b>33,60</b>		
	049834			
<b>BHT – P.20</b> 10 Bielo hliníková tmavá RAL 9007	32,50	<b>39,00</b>		
	095749 *			
<b>MZ</b> 11 Machovo zelená RAL 6005	28,00	<b>33,60</b>		
	049858			
<b>MOT</b> 12 Tmavo modrá RAL 5010	28,00	<b>33,60</b>		
	049841 *			
<b>TZ</b> 13 Trávovo zelená RAL 6011	28,00	<b>33,60</b>		
	049940 *			
<b>Balenie v m</b> 	<b>4</b>		<b>6</b>	
<b>Balenie v m</b> 	<b>400</b>		<b>300</b>	

\* Výroba na objednávku



## STREŠNÝ DILATAČNÝ ŽLAB POLKRUHOVÝ

P-PZDI

Menovitá veľkosť	250/260		280/260		333/260		400/260	
	Bez DPH	S DPH	Bez DPH	S DPH	Bez DPH	S DPH	Bez DPH	S DPH
<b>TM</b> 1 Testa di Moro RAL 8028	14,60	<b>17,52</b>	15,50	<b>18,60</b>	16,90	<b>20,28</b>	19,90	<b>23,88</b>
	013064		013071		013088		013095	
<b>AN</b> 2 Antracit RAL 7016	14,60	<b>17,52</b>	15,50	<b>18,60</b>	16,90	<b>20,28</b>	19,90	<b>23,88</b>
	012661		012678		012685		012692	
<b>IC</b> 3 Intenzívna čierna RAL 9005	14,60	<b>17,52</b>	15,50	<b>18,60</b>	16,90	<b>20,28</b>	19,90	<b>23,88</b>
	012746 *		012753 *		012760		012777 *	
<b>OC</b> 4 Oceľovo červená RAL 3009	14,60	<b>17,52</b>	15,50	<b>18,60</b>	16,90	<b>20,28</b>	19,90	<b>23,88</b>
	012944 *		012951 *		012968 *		012975 *	
<b>MH</b> 5 Medeno hnedá RAL 8004	14,60	<b>17,52</b>	15,50	<b>18,60</b>	16,90	<b>20,28</b>	19,90	<b>23,88</b>
	012784 *		012791 *		012807 *		012814 *	
<b>SB</b> 6 Šedo biela RAL 9002	14,60	<b>17,52</b>	15,50	<b>18,60</b>	16,90	<b>20,28</b>	19,90	<b>23,88</b>
	013026 *		013033 *		013040 *		013057 *	
<b>BH</b> 7 Bielo hliníková RAL 9006	14,60	<b>17,52</b>	15,50	<b>18,60</b>	16,90	<b>20,28</b>	19,90	<b>23,88</b>
	012708 *		012715 *		012722 *		012739 *	
<b>PS</b> 8 Prachovo šedá RAL 7037	14,60	<b>17,52</b>	15,50	<b>18,60</b>	16,90	<b>20,28</b>	19,90	<b>23,88</b>
	012982 *		012999 *		013002 *		013019 *	
<b>MM</b> 9 Metalická medená RAL extra	14,60	<b>17,52</b>	15,50	<b>18,60</b>	16,90	<b>20,28</b>	19,90	<b>23,88</b>
	012821 *		012838 *		012845 *		012852 *	
<b>BHT – P.20</b> 10 Bielo hliníková tmavá RAL 9007	14,60	<b>17,52</b>	15,50	<b>18,60</b>	16,90	<b>20,28</b>	19,90	<b>23,88</b>
	096098 *		096104 *		096111 *		114044 *	
<b>MZ</b> 11 Machovo zelená RAL 6005	14,60	<b>17,52</b>	15,50	<b>18,60</b>	16,90	<b>20,28</b>	19,90	<b>23,88</b>
	012906 *		012913 *		012920 *		012937 *	
<b>MOT</b> 12 Tmavo modrá RAL 5010	14,60	<b>17,52</b>	15,50	<b>18,60</b>	16,90	<b>20,28</b>	19,90	<b>23,88</b>
	012869 *		012876 *		012883 *		012890 *	
<b>TZ</b> 13 Trávovo zelená RAL 6011	14,60	<b>17,52</b>	15,50	<b>18,60</b>	16,90	<b>20,28</b>	19,90	<b>23,88</b>
	013101 *		013118 *		013125 *		013132 *	
<b>Balenie v ks</b> 📦	<b>3</b>		<b>3</b>		<b>5</b>		<b>5</b>	
<b>Balenie v ks</b> 🚚	<b>360</b>		<b>360</b>		<b>200</b>		<b>200</b>	

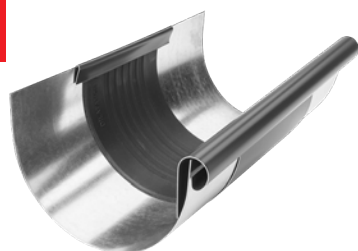

\* Výroba na objednávku



## DILATAČNÝ ŽĽAB NÁSTREŠNÝ – SAMRÍNA

P-PZSDI





Menovitá veľkosť	670/260	
	Bez DPH	S DPH
<b>TM</b> 1 Testa di Moro RAL 8028	31,50	37,80
	013637 *	
<b>AN</b> 2 Antracit RAL 7016	31,50	37,80
	013545 *	
<b>IC</b> 3 Intenzívna čierna RAL 9005	31,50	37,80
	013569 *	
<b>OC</b> 4 Oceľovo červená RAL 3009	31,50	37,80
	013606 *	
<b>MH</b> 5 Medeno hnedá RAL 8004	31,50	37,80
	013576 *	
<b>SB</b> 6 Šedo biela RAL 9002	31,50	37,80
	013620 *	
<b>BH</b> 7 Bielo hliníková RAL 9006	31,50	37,80
	013552 *	
<b>PS</b> 8 Prachovo šedá RAL 7037	31,50	37,80
	013613 *	
<b>MM</b> 9 Metalická medená RAL extra	31,50	37,80
	013583 *	
<b>BHT – P.20</b> 10 Bielo hliníková tmavá RAL 9007	31,50	37,80
	096067 *	
<b>MZ</b> 11 Machovo zelená RAL 6005	31,50	37,80
	013651 *	
<b>MOT</b> 12 Tmavo modrá RAL 5010	31,50	37,80
	013590 *	
<b>TZ</b> 13 Trávovo zelená RAL 6011	31,50	37,80
	013644 *	
<b>Balenie v ks</b> 	1	
<b>Balenie v ks</b> 	40	

\* Výroba na objednávku

## DILATAČNÝ PÁS

P-PZDIP



Menovitá veľkosť	Dĺžka v m	EAN číslo výrobku	Balenie v m		Cena [€/m]	
					Bez DPH	S DPH
260	3,0	012470	3	120	33,60	40,32
260	6,0	012487	6	240	33,60	40,32

## POUŽITIE DILATAČNÉHO ŽĽABU A DILATAČNÉHO PÁSU

### DILATAČNÝ ŽĽAB

**Príklad montáže: Pododkvapový žľab o rozvinutej šírke do 500 mm.** Dilatačný žľab musí byť namontovaný v rozostupe 15 m. Pre vonkajší roh a začiatok žľabu platí polovica štandardnej hodnoty: maximálne 7,5 m. Pre vnútorný roh platí štvrtina štandardnej hodnoty: maximálne 3,75 m. Pre ostatné materiály a rozmery: pozri tabuľku nižšie. Rohy sa vždy počítajú ako pevné body.

### POLKRUHOVÉ DILATAČNÉ ŽĽABY

Rozvinutá šírka žľabu	Hliník	Pozink, Titán-zinok, Meď, Nerez
< 500	12	15
> 500	8	10

### DILATAČNÝ PÁS

**Vnútorňa inštalácia:** na žľaby uchytené bez lepenia na podklad, strechy s neštandardným profilom a oplechovania muriva

### DILATAČNÝ PÁS

Rozvinutá šírka žľabu	Hliník	Pozink, Titán-zinok, Meď, Nerez
< 500	8	10
> 500	6	8

Pre vonkajší roh alebo začiatok žľabu platí polovica štandardnej hodnoty. Pre vnútorný roh platí jedna štvrtina štandardnej hodnoty.

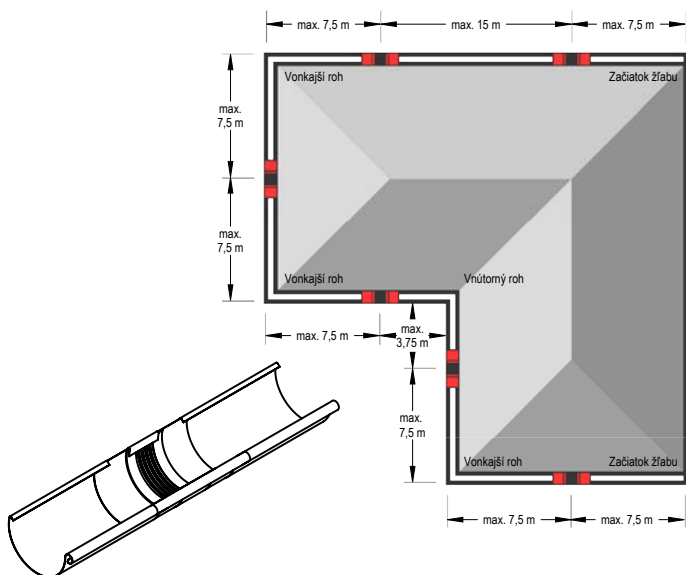

#### Poznámka k montáži dilatačného žľabu.

Pri montáži pomocou spájkovania najprv stredný gumový diel prekryte mokrou handričkou (aby nedošlo k prestupu tepla do stredného gumového dielu). Musí sa dodržať minimálna vzdialenosť 6 cm od strednej gumovej časti. V každom prípade sa treba vyhýbať kontaktu gumeného dielu s otvoreným plameňom.

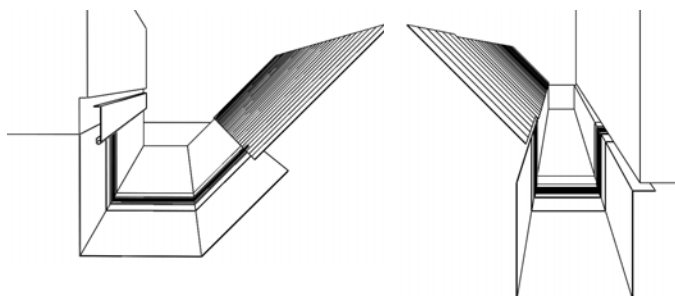

#### Poznámka k montáži dilatačného pásu.

Pri ohýbaní a montáži dilatačných prvkov sa uistite, že:

- Ohýbacie čeluste majú rádius minimálne 2 mm.
- Pre hrúbku plechu od 1 mm musí byť dodržaný polomer ohybu minimálne 5 mm.
- Ohýbacie čeluste musia byť pri ohýbaní nastavené na hrúbku strednej gumovej časti 3 až 4 mm, aby sa zabránilo strihaciemu efektu – poškodeniu gumeného dielu.
- Gumová stredná časť nesmie byť počas ohýbania stlačená alebo poškodená. Preto by mal byť použitý hliníkový plechový pás 2 až 5 mm (hrubý) ohnutý tak, aby mohol byť pripevnený ako ochrana na ohýbacie čeluste. Tým sa dosiahne väčší polomer ohybu a zabráni sa porušeniu gumovej strednej časti.

## HLINÍKOVÁ MRIEŽKA ZACHYTÁVAČA NEČISTÔT

P-PZNL M

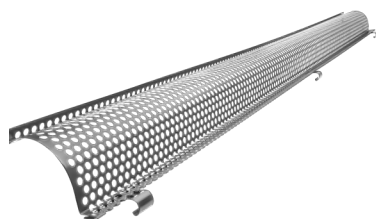



Menovitá veľkosť	333	
Dĺžka v m	2,0	
Cena v €/ks	Bez DPH	S DPH
<b>TM</b> 1 Testa di Moro RAL 8028	26,50	31,80
	064943	
<b>AN</b> 2 Antracit RAL 7016	26,50	31,80
	064912	
<b>IC</b> 3 Intenzívna čierna RAL 9005	26,50	31,80
	064929 *	
<b>OC</b> 4 Oceľovo červená RAL 3009	26,50	31,80
	064936 *	
<b>MH</b> 5 Medeno hnedá RAL 8004	26,50	31,80
	119766 *	
<b>SB</b> 6 Šedo biela RAL 9002	26,50	31,80
	117762 *	
<b>BH</b> 7 Bielo hliníková RAL 9006	26,50	31,80
	117717 *	
<b>PS</b> 8 Prachovo šedá RAL 7037	26,50	31,80
	117755 *	
<b>MM</b> 9 Metalická medená RAL extra	26,50	31,80
	117724 *	
<b>BHT – P.20</b> 10 Bielo hliníková tmavá RAL 9007	26,50	31,80
	097156 *	
<b>MZ</b> 11 Machovo zelená RAL 6005	26,50	31,80
	117748 *	
<b>MOT</b> 12 Tmavo modrá RAL 5010	26,50	31,80
	117731 *	
<b>TZ</b> 13 Trávovo zelená RAL 6011	26,50	31,80
	117779 *	
<b>Balenie v ks</b> 📦	15	
<b>Balenie v ks</b> 🚚	120	

\* Výroba na objednávku

# POZINK POLYESTER



## PVC MRIEŽKA ZACHYTÁVAČA LÍSTIA

## SD-ZNL MRIEZKA

Menovitá veľkosť	Dĺžka v m	EAN číslo výrobku	Balenie v ks		Cena [€/ks]	
					Bez DPH	S DPH
<b>PS 171</b>	1,0	008473	30	450	4,50	<b>5,40</b>
<b>TM 171</b>	1,0	008466	30	450	4,50	<b>5,40</b>

## PVC MRIEŽKA ZACHYTÁVAČA LÍSTIA

## SD-ZNL N

Menovitá veľkosť	Dĺžka v m	EAN číslo výrobku	Balenie v ks		Cena [€/ks]	
					Bez DPH	S DPH
<b>250</b>	3,0	008480	10	400	23,90	<b>28,68</b>
<b>280-333</b>	3,0	008497	10	400	24,00	<b>28,80</b>

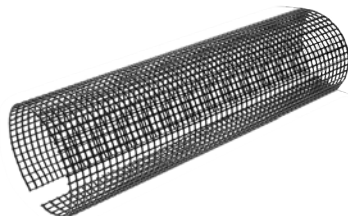
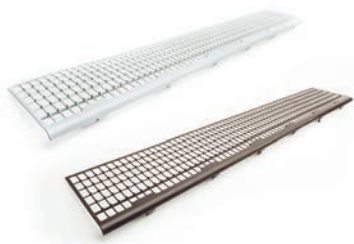



### DRŽIAK NÁVALKY STREŠNÉHO ŽLABU

P-PDZNV



Menovitá veľkosť	250-280		333		400	
	Rozmer v mm		20		22	
Cena v €/ks	Bez DPH	S DPH	Bez DPH	S DPH	Bez DPH	S DPH
	<b>TM</b> 1 Testa di Moro RAL 8028	1,60	<b>1,92</b>	1,60	<b>1,92</b>	1,60
085665		085672		085689 *		
<b>AN</b> 2 Antracit RAL 7016	1,60	<b>1,92</b>	1,60	<b>1,92</b>	1,60	<b>1,92</b>
	085290		085306		085313	
<b>IC</b> 3 Intenzívna čierna RAL 9005	1,60	<b>1,92</b>	1,60	<b>1,92</b>	1,60	<b>1,92</b>
	085351		085368		085375 *	
<b>OC</b> 4 Oceľovo červená RAL 3009	1,60	<b>1,92</b>	1,60	<b>1,92</b>	1,60	<b>1,92</b>
	085504		085573		085597 *	
<b>MH</b> 5 Medeno hnedá RAL 8004	1,60	<b>1,92</b>	1,60	<b>1,92</b>	1,60	<b>1,92</b>
	085382		085399		085405 *	
<b>SB</b> 6 Šedo biela RAL 9002	1,60	<b>1,92</b>	1,60	<b>1,92</b>	1,60	<b>1,92</b>
	085634 *		085641		085658 *	
<b>BH</b> 7 Bielo hliníková RAL 9006	1,60	<b>1,92</b>	1,60	<b>1,92</b>	1,60	<b>1,92</b>
	085320		085337		085344 *	
<b>PS</b> 8 Prachovo šedá RAL 7037	1,60	<b>1,92</b>	1,60	<b>1,92</b>	1,60	<b>1,92</b>
	085603		085610		085627 *	
<b>MM</b> 9 Metalická medená RAL extra	1,60	<b>1,92</b>	1,60	<b>1,92</b>	1,60	<b>1,92</b>
	085412 *		085429		085436 *	
<b>BHT – P.20</b> 10 Bielo hliníková tmavá RAL 9007	1,60	<b>1,92</b>	1,60	<b>1,92</b>	1,60	<b>1,92</b>
	094636 *		094643 *		094650 *	
<b>MZ</b> 11 Machovo zelená RAL 6005	1,60	<b>1,92</b>	1,60	<b>1,92</b>	1,60	<b>1,92</b>
	085474 *		085481 *		085498 *	
<b>MOT</b> 12 Tmavo modrá RAL 5010	1,60	<b>1,92</b>	1,60	<b>1,92</b>	1,60	<b>1,92</b>
	085443 *		085450 *		085467 *	
<b>TZ</b> 13 Trávovo zelená RAL 6011	1,60	<b>1,92</b>	1,60	<b>1,92</b>	1,60	<b>1,92</b>
	085696 *		085702 *		085719 *	
<b>Balenie v ks</b> 📦	<b>25</b>		<b>25</b>		<b>25</b>	
<b>Balenie v ks</b> 🚚	<b>3 000</b>		<b>3 000</b>		<b>3 000</b>	

\* Výroba na objednávku



## SPOJKA STREŠNÉHO ŽLABU

P-PSPZ

Menovitá veľkosť	250		280		333	
	Bez DPH	S DPH	Bez DPH	S DPH	Bez DPH	S DPH
<b>TM</b> 1 Testa di Moro RAL 8028	3,80	<b>4,56</b>	3,80	<b>4,56</b>	4,00	<b>4,80</b>
	083852		083869		083876	
<b>AN</b> 2 Antracit RAL 7016	3,80	<b>4,56</b>	3,80	<b>4,56</b>	4,00	<b>4,80</b>
	083456		083463		083470	
<b>IC</b> 3 Intenzívna čierna RAL 9005	3,80	<b>4,56</b>	3,80	<b>4,56</b>	4,00	<b>4,80</b>
	083531		083548		083555	
<b>OC</b> 4 Oceľovo červená RAL 3009	3,80	<b>4,56</b>	3,80	<b>4,56</b>	4,00	<b>4,80</b>
	083739		083746		083753	
<b>MH</b> 5 Medeno hnedá RAL 8004	3,80	<b>4,56</b>	3,80	<b>4,56</b>	4,00	<b>4,80</b>
	083579		083586		083593	
<b>SB</b> 6 Šedo biela RAL 9002	3,80	<b>4,56</b>	3,80	<b>4,56</b>	4,00	<b>4,80</b>
	083814		083821		083838	
<b>BH</b> 7 Bielo hliníková RAL 9006	3,80	<b>4,56</b>	3,80	<b>4,56</b>	4,00	<b>4,80</b>
	083494		083500		083517	
<b>PS</b> 8 Prachovo šedá RAL 7037	3,80	<b>4,56</b>	3,80	<b>4,56</b>	4,00	<b>4,80</b>
	083777		083784		083791	
<b>MM</b> 9 Metalická medená RAL extra	3,80	<b>4,56</b>	3,80	<b>4,56</b>	4,00	<b>4,80</b>
	083616		083623		083630	
<b>BHT – P.20</b> 10 Bielo hliníková tmavá RAL 9007	3,80	<b>4,56</b>	3,80	<b>4,56</b>	4,00	<b>4,80</b>
	094681		094698 *		094704	
<b>MZ</b> 11 Machovo zelená RAL 6005	3,80	<b>4,56</b>	3,80	<b>4,56</b>	4,00	<b>4,80</b>
	083692		083708		083715	
<b>MOT</b> 12 Tmavo modrá RAL 5010	3,80	<b>4,56</b>	3,80	<b>4,56</b>	4,00	<b>4,80</b>
	083654		083661		083678	
<b>TZ</b> 13 Trávovo zelená RAL 6011	3,80	<b>4,56</b>	3,80	<b>4,56</b>	4,00	<b>4,80</b>
	083890 *		083906 *		083913	
<b>Balenie v ks</b> 	<b>5</b>		<b>5</b>		<b>5</b>	
<b>Balenie v ks</b> 	<b>600</b>		<b>600</b>		<b>600</b>	

\* Výroba na objednávku



### STREŠNÝ ŽLABOVÝ HÁK S PRELISOM

P-PHP

Menovitá veľkosť	200/380		250/430		280/480		280/480	
	25/4		25/5		25/5		30/5	
Materiál	25/4		25/5		25/5		30/5	
	Bez DPH	S DPH	Bez DPH	S DPH	Bez DPH	S DPH	Bez DPH	S DPH
<b>TM</b> Testa di Moro RAL 8028	3,95	<b>4,74</b>	3,50	<b>4,20</b>	3,70	<b>4,44</b>	4,15	<b>4,98</b>
	045362		045379		045386		045393	
<b>AN</b> Antracit RAL 7016	3,95	<b>4,74</b>	3,50	<b>4,20</b>	3,70	<b>4,44</b>	4,15	<b>4,98</b>
	044648		044655		044662		044679	
<b>IC</b> Intenzívna čierna RAL 9005	3,95	<b>4,74</b>	3,50	<b>4,20</b>	3,70	<b>4,44</b>	4,15	<b>4,98</b>
	044808		044815		044822		044839	
<b>OC</b> Oceľovo červená RAL 3009	3,95	<b>4,74</b>	3,50	<b>4,20</b>	3,70	<b>4,44</b>	4,15	<b>4,98</b>
	045140		045157		045164		045171	
<b>MH</b> Medeno hnedá RAL 8004	3,95	<b>4,74</b>	3,50	<b>4,20</b>	3,70	<b>4,44</b>	4,15	<b>4,98</b>
	044884		044891		044907		044914	
<b>SB</b> Šedo biela RAL 9002	3,95	<b>4,74</b>	3,50	<b>4,20</b>	3,70	<b>4,44</b>	4,15	<b>4,98</b>
	045287		045294		045300		045317	
<b>BH</b> Bielo hliníková RAL 9006	3,95	<b>4,74</b>	3,50	<b>4,20</b>	3,70	<b>4,44</b>	4,15	<b>4,98</b>
	044723		044730		044747		044754	
<b>PS</b> Prachovo šedá RAL 7037	3,95	<b>4,74</b>	3,50	<b>4,20</b>			4,15	<b>4,98</b>
	045225		045232				045249	
<b>MM</b> Metalická medená RAL extra	3,95	<b>4,74</b>	3,50	<b>4,20</b>			4,15	<b>4,98</b>
	044969		044976				044983	
<b>BHT – P.20</b> Bielo hliníková tmavá RAL 9007			3,50	<b>4,20</b>			4,15	<b>4,98</b>
			095961				095978	
<b>MZ</b> Machovo zelená RAL 6005	3,95	<b>4,74</b>	3,50	<b>4,20</b>			4,15	<b>4,98</b>
	045089		045096				045102	
<b>MOT</b> Tmavo modrá RAL 5010	3,95	<b>4,74</b>	3,50	<b>4,20</b>			4,15	<b>4,98</b>
	045027		045034				045041	
<b>TZ</b> Trávovo zelená RAL 6011	3,95	<b>4,74</b>	3,50	<b>4,20</b>			4,15	<b>4,98</b>
	045454 *		045461				045478	
<b>Balenie v ks</b> 	<b>25</b>		<b>25</b>		<b>25</b>		<b>25</b>	
<b>Balenie v ks</b> 	<b>1 000</b>		<b>1 000</b>		<b>1 000</b>		<b>1 000</b>	

\* Výroba na objednávku



## STREŠNÝ ŽLABOVÝ HÁK S PRELISOM

P-PHP

Menovitá veľkosť	333/550		333/550		333/550		333/610		400/610	
	25/5		30/4		30/5		30/5		30/6	
Materiál	25/5		30/4		30/5		30/5		30/6	
	Bez DPH	S DPH	Bez DPH	S DPH	Bez DPH	S DPH	Bez DPH	S DPH	Bez DPH	S DPH
<b>TM</b> Testa di Moro RAL 8028	3,90	4,68	4,20	5,04	4,20	5,04	5,10	6,12	6,95	8,34
	045409		045416 *		045423		045430		045447	
<b>AN</b> Antracit RAL 7016	3,90	4,68	4,20	5,04	4,20	5,04	5,10	6,12	6,95	8,34
	044686		080127 *		044693		044709		044716	
<b>IC</b> Intenzívna čierna RAL 9005	3,90	4,68			4,20	5,04	5,10	6,12	6,95	8,34
	044846				044853		044860		044877	
<b>OC</b> Oceľovo červená RAL 3009	3,90	4,68			4,20	5,04	5,10	6,12	6,95	8,34
	045188				045195		045201		045218	
<b>MH</b> Medeno hnedá RAL 8004	3,90	4,68			4,20	5,04	5,10	6,12	6,95	8,34
	044921				044938		044945		044952 *	
<b>SB</b> Šedo biela RAL 9002	3,90	4,68			4,20	5,04	5,10	6,12	6,95	8,34
	045324				045331		045348		045355	
<b>BH</b> Bielo hliníková RAL 9006	3,90	4,68			4,20	5,04	5,10	6,12	6,95	8,34
	044761				044778		044785		044792	
<b>PS</b> Prachovo šedá RAL 7037					4,20	5,04	5,10	6,12	6,95	8,34
					045256		045263		045270	
<b>MM</b> Metalická medená RAL extra					4,20	5,04	5,10	6,12	6,95	8,34
					044990		045003		045010	
<b>BHT – P.20</b> Bielo hliníková tmavá RAL 9007					4,20	5,04			6,95	8,34
					095985				095992	
<b>MZ</b> Machovo zelená RAL 6005					4,20	5,04	5,10	6,12	6,95	8,34
					045119		045126		045133	
<b>MOT</b> Tmavo modrá RAL 5010					4,20	5,04	5,10	6,12	6,95	8,34
					045058		045065		045072	
<b>TZ</b> Trávovo zelená RAL 6011					4,20	5,04	5,10	6,12	6,95	8,34
					045485		045492		045508 *	
<b>Balenie v ks</b> 📦	25		25		25		25		25	
<b>Balenie v ks</b> 🚚	1 000		1 000		1 000		1 000		500	



\* Výroba na objednávku

POZINK  
POLYESTER



## STREŠNÝ ŽLABOVÝ HÁK POLKRUHOVÝ NOS



P-PHPN

Menovitá veľkosť	250/430		280/480		333/550	
Materiál	25/5		25/5		30/5	
Cena v €/ks	Bez DPH	S DPH	Bez DPH	S DPH	Bez DPH	S DPH
<b>TM</b> 1 Testa di Moro RAL 8028	3,30	<b>3,96</b>	3,30	<b>3,96</b>	3,60	<b>4,32</b>
	095930		095947		095954	
<b>AN</b> 2 Antracit RAL 7016	3,30	<b>3,96</b>	3,30	<b>3,96</b>	3,60	<b>4,32</b>
	095824		095831		095848	
<b>IC</b> 3 Intenzívna čierna RAL 9005			3,30	<b>3,96</b>	3,60	<b>4,32</b>
			095879		095886 *	
<b>MH</b> 5 Medeno hnedá RAL 8004			3,30	<b>3,96</b>	3,60	<b>4,32</b>
			095893		095909	
<b>SB</b> 6 Šedo biela RAL 9002			3,30	<b>3,96</b>	3,60	<b>4,32</b>
			095916		095923 *	
<b>BH</b> 7 Bielo hliníková RAL 9006			3,30	<b>3,96</b>	3,60	<b>4,32</b>
			095855		095862	
<b>PS</b> 8 Prachovo šedá RAL 7037					3,60	<b>4,32</b>
					117496 *	
Balenie v ks 	25		25		25	
Balenie v ks 	1 000		1 000		1 000	

\* Výroba na objednávku

## STREŠNÝ ŽLABOVÝ HÁK NOS KROKVA

P-PHPNK



Menovitá veľkosť	250		280		333	
Materiál	25/4		25/4		25/5	
Cena v €/ks	Bez DPH	S DPH	Bez DPH	S DPH	Bez DPH	S DPH
<b>TM</b> 1 Testa di Moro RAL 8028	3,50	<b>4,20</b>	3,75	<b>4,50</b>	4,00	<b>4,80</b>
	095435		095442		095459	
<b>AN</b> 2 Antracit RAL 7016	3,50	<b>4,20</b>	3,75	<b>4,50</b>	4,00	<b>4,80</b>
	095312		095329		095336	
<b>IC</b> 3 Intenzívna čierna RAL 9005	3,50	<b>4,20</b>	3,75	<b>4,50</b>	4,00	<b>4,80</b>
	095374		095381		095398	
<b>MH</b> 5 Medeno hnedá RAL 8004	3,50	<b>4,20</b>	3,75	<b>4,50</b>	4,00	<b>4,80</b>
	095404		095411		095428	
<b>BH</b> 7 Bielo hliníková RAL 9006	3,50	<b>4,20</b>	3,75	<b>4,50</b>	4,00	<b>4,80</b>
	095343 *		095350		095367	
Balenie v ks 	25		25		25	
Balenie v ks 	1 000		1 000		1 000	

\* Výroba na objednávku



## NÁSTREŠNÝ HÁK SAMRÍNOVÝ SPEVNENÝ

P-PHSSN

Menovitá veľkosť	4	
Materiál	20/6	
Cena v €/ks	Bez DPH	S DPH
<b>TM</b> 1 Testa di Moro RAL 8028	9,50	11,40
	033567	
<b>AN</b> 2 Antracit RAL 7016	9,50	11,40
	033468	
<b>IC</b> 3 Intenzívna čierna RAL 9005	9,50	11,40
	033482	
<b>OC</b> 4 Oceľovo červená RAL 3009	9,50	11,40
	033536	
<b>MH</b> 5 Medeno hnedá RAL 8004	9,50	11,40
	033499	
<b>SB</b> 6 Šedo biela RAL 9002	9,50	11,40
	033550	
<b>BH</b> 7 Bielo hliníková RAL 9006	9,50	11,40
	033475	
<b>PS</b> 8 Prachovo šedá RAL 7037	9,50	11,40
	033543	
<b>MM</b> 9 Metalická medená RAL extra	9,50	11,40
	033505	
<b>BHT – P.20</b> 10 Bielo hliníková tmavá RAL 9007	9,50	11,40
	095510 *	
<b>MZ</b> 11 Machovo zelená RAL 6005	9,50	11,40
	033529	
<b>MOT</b> 12 Tmavo modrá RAL 5010	9,50	11,40
	033512 *	
<b>TZ</b> 13 Trávovo zelená RAL 6011	9,50	11,40
	033574	
<b>Balenie v ks</b> 	25	
<b>Balenie v ks</b> 	1 000	

\* Výroba na objednávku





POZINK  
POLYESTER

## STREŠNÝ ŽLABOVÝ HÁK KROKVA

P-PHPK





Menovitá veľkosť	200		250		280		333		400	
	25/4		25/4		25/4		25/5		30/5	
Materiál	25/4		25/4		25/4		25/5		30/5	
	Bez DPH	S DPH	Bez DPH	S DPH	Bez DPH	S DPH	Bez DPH	S DPH	Bez DPH	S DPH
<b>TM</b> Testa di Moro RAL 8028	4,00	<b>4,80</b>	3,75	<b>4,50</b>	4,05	<b>4,86</b>	4,40	<b>5,28</b>	6,10	<b>7,32</b>
	065551		065568		065575		065582		065599	
<b>AN</b> Antracit RAL 7016	4,00	<b>4,80</b>	3,75	<b>4,50</b>	4,05	<b>4,86</b>	4,40	<b>5,28</b>	6,10	<b>7,32</b>
	065056		065063		065070		065087		065094	
<b>IC</b> Intenzívna čierna RAL 9005	4,00	<b>4,80</b>	3,75	<b>4,50</b>	4,05	<b>4,86</b>	4,40	<b>5,28</b>	6,10	<b>7,32</b>
	065155		065162		065179		065186		065193 *	
<b>OC</b> Oceľovo červená RAL 3009	4,00	<b>4,80</b>	3,75	<b>4,50</b>	4,05	<b>4,86</b>	4,40	<b>5,28</b>	6,10	<b>7,32</b>
	065407		065414		065421		065438		065445	
<b>MH</b> Medeno hnedá RAL 8004	4,00	<b>4,80</b>	3,75	<b>4,50</b>	4,05	<b>4,86</b>	4,40	<b>5,28</b>	6,10	<b>7,32</b>
	065209		065216		065223		065230		065247 *	
<b>SB</b> Šedo biela RAL 9002	4,00	<b>4,80</b>	3,75	<b>4,50</b>	4,05	<b>4,86</b>	4,40	<b>5,28</b>	6,10	<b>7,32</b>
	065506		065513		065520		065537		065544	
<b>BH</b> Bielo hliníková RAL 9006	4,00	<b>4,80</b>	3,75	<b>4,50</b>	4,05	<b>4,86</b>	4,40	<b>5,28</b>	6,10	<b>7,32</b>
	065100		065117		065124		065131		065148	
<b>PS</b> Prachovo šedá RAL 7037	4,00	<b>4,80</b>	3,75	<b>4,50</b>	4,05	<b>4,86</b>	4,40	<b>5,28</b>	6,10	<b>7,32</b>
	065452		065469		065476		065483		065490	
<b>MM</b> Metalická medená RAL extra	4,00	<b>4,80</b>	3,75	<b>4,50</b>	4,05	<b>4,86</b>	4,40	<b>5,28</b>	6,10	<b>7,32</b>
	065254		065261		065278		065285		065292 *	
<b>BHT – P.20</b> Bielo hliníková tmavá RAL 9007			3,75	<b>4,50</b>	4,05	<b>4,86</b>	4,40	<b>5,28</b>		
			095251		095268		095275			
<b>MZ</b> Machovo zelená RAL 6005	4,00	<b>4,80</b>	3,75	<b>4,50</b>	4,05	<b>4,86</b>	4,40	<b>5,28</b>	6,10	<b>7,32</b>
	065353		065360		065377		065384		065391 *	
<b>MOT</b> Tmavo modrá RAL 5010	4,00	<b>4,80</b>	3,75	<b>4,50</b>	4,05	<b>4,86</b>	4,40	<b>5,28</b>	6,10	<b>7,32</b>
	065308 *		065315		065322		065339		065346	
<b>TZ</b> Trávovo zelená RAL 6011	4,00	<b>4,80</b>	3,75	<b>4,50</b>	4,05	<b>4,86</b>	4,40	<b>5,28</b>	6,10	<b>7,32</b>
	065605 *		065612 *		065629 *		065636 *		065643 *	
<b>Balenie v ks</b> 	<b>25</b>		<b>25</b>		<b>25</b>		<b>25</b>		<b>20</b>	
<b>Balenie v ks</b> 	<b>1 000</b>		<b>1 000</b>		<b>1 000</b>		<b>1 000</b>		<b>800</b>	

\* Výroba na objednávku

## ŽLABOVÝ ROH VONKAJŠÍ

P-PRA

Menovitá veľkosť	200		250		280		333		400	
	Bez DPH	S DPH	Bez DPH	S DPH	Bez DPH	S DPH	Bez DPH	S DPH	Bez DPH	S DPH
<b>TM</b> 1 Testa di Moro RAL 8028	11,90	<b>14,28</b>	11,70	<b>14,04</b>	11,80	<b>14,16</b>	11,90	<b>14,28</b>	29,90	<b>35,88</b>
	075673		075680		075697		075703		075710	
<b>AN</b> 2 Antracit RAL 7016	11,90	<b>14,28</b>	11,70	<b>14,04</b>	11,80	<b>14,16</b>	11,90	<b>14,28</b>	29,90	<b>35,88</b>
	075178		075185		075192		075208		075215	
<b>IC</b> 3 Intenzívna čierna RAL 9005	11,90	<b>14,28</b>	11,70	<b>14,04</b>	11,80	<b>14,16</b>	11,90	<b>14,28</b>	29,90	<b>35,88</b>
	075260		075284		075291		075307		075314	
<b>OC</b> 4 Oceľovo červená RAL 3009	11,90	<b>14,28</b>	11,70	<b>14,04</b>	11,80	<b>14,16</b>	11,90	<b>14,28</b>	29,90	<b>35,88</b>
	075529		075536		075543		075567		075550	
<b>MH</b> 5 Medeno hnedá RAL 8004	11,90	<b>14,28</b>	11,70	<b>14,04</b>	11,80	<b>14,16</b>	11,90	<b>14,28</b>	29,90	<b>35,88</b>
	075321		075338		075345		075352		075369	
<b>SB</b> 6 Šedo biela RAL 9002	11,90	<b>14,28</b>	11,70	<b>14,04</b>	11,80	<b>14,16</b>	11,90	<b>14,28</b>	29,90	<b>35,88</b>
	075635		075628		075642		075659		075666	
<b>BH</b> 7 Bielo hliníková RAL 9006	11,90	<b>14,28</b>	11,70	<b>14,04</b>	11,80	<b>14,16</b>	11,90	<b>14,28</b>	29,90	<b>35,88</b>
	075222		075239		075246		075253		075277	
<b>PS</b> 8 Prachovo šedá RAL 7037	11,90	<b>14,28</b>	11,70	<b>14,04</b>	11,80	<b>14,16</b>	11,90	<b>14,28</b>	29,90	<b>35,88</b>
	075574		075581		075598		075604		075611	
<b>MM</b> 9 Metalická medená RAL extra	11,90	<b>14,28</b>	11,70	<b>14,04</b>	11,80	<b>14,16</b>	11,90	<b>14,28</b>	29,90	<b>35,88</b>
	075376		075383		075390		075406		075413	
<b>BHT – P.20</b> 10 Bielo hliníková tmavá RAL 9007			11,70	<b>14,04</b>	11,80	<b>14,16</b>	11,90	<b>14,28</b>	29,90	<b>35,88</b>
			094384		094391 *		094407		110695	
<b>MZ</b> 11 Machovo zelená RAL 6005	11,90	<b>14,28</b>	11,70	<b>14,04</b>	11,80	<b>14,16</b>	11,90	<b>14,28</b>	29,90	<b>35,88</b>
	075475		075482		075499		075505		075512	
<b>MOT</b> 12 Tmavo modrá RAL 5010	11,90	<b>14,28</b>	11,70	<b>14,04</b>	11,80	<b>14,16</b>	11,90	<b>14,28</b>	29,90	<b>35,88</b>
	075420		075437		075444		075451		075468	
<b>TZ</b> 13 Trávovo zelená RAL 6011	11,90	<b>14,28</b>	11,70	<b>14,04</b>	11,80	<b>14,16</b>	11,90	<b>14,28</b>	29,90	<b>35,88</b>
	075727 *		075734		075741		075758		075765 *	
<b>Balenie v ks</b> 	<b>5</b>		<b>5</b>		<b>5</b>		<b>5</b>		<b>5</b>	
<b>Balenie v ks</b> 	<b>150</b>		<b>150</b>		<b>150</b>		<b>150</b>		<b>150</b>	

\* Výroba na objednávku

POZINK  
POLYESTER





## ŽLABOVÝ ROH VNÚTORNÝ

P-PRI



Menovitá veľkosť	200		250		280		333		400	
	Bez DPH	S DPH	Bez DPH	S DPH	Bez DPH	S DPH	Bez DPH	S DPH	Bez DPH	S DPH
<b>TM</b> 1 Testa di Moro RAL 8028	11,90	<b>14,28</b>	11,70	<b>14,04</b>	11,80	<b>14,16</b>	11,90	<b>14,28</b>	29,90	<b>35,88</b>
	076281		076274		076298		076304		076311	
<b>AN</b> 2 Antracit RAL 7016	11,90	<b>14,28</b>	11,70	<b>14,04</b>	11,80	<b>14,16</b>	11,90	<b>14,28</b>	29,90	<b>35,88</b>
	075772		075789		075796		075802		075819	
<b>IC</b> 3 Intenzívna čierna RAL 9005	11,90	<b>14,28</b>	11,70	<b>14,04</b>	11,80	<b>14,16</b>	11,90	<b>14,28</b>	29,90	<b>35,88</b>
	075871		075888		075895		075901		075918	
<b>OC</b> 4 Oceľovo červená RAL 3009	11,90	<b>14,28</b>	11,70	<b>14,04</b>	11,80	<b>14,16</b>	11,90	<b>14,28</b>	29,90	<b>35,88</b>
	076120		076137		076144		076168		076151	
<b>MH</b> 5 Medeno hnedá RAL 8004	11,90	<b>14,28</b>	11,70	<b>14,04</b>	11,80	<b>14,16</b>	11,90	<b>14,28</b>	29,90	<b>35,88</b>
	075925		075932		075949		075956		075963	
<b>SB</b> 6 Šedo biela RAL 9002	11,90	<b>14,28</b>	11,70	<b>14,04</b>	11,80	<b>14,16</b>	11,90	<b>14,28</b>	29,90	<b>35,88</b>
	076229		076236		076243		076250		076267	
<b>BH</b> 7 Bielo hliníková RAL 9006	11,90	<b>14,28</b>	11,70	<b>14,04</b>	11,80	<b>14,16</b>	11,90	<b>14,28</b>	29,90	<b>35,88</b>
	075826		075833		075840		075857		075864	
<b>PS</b> 8 Prachovo šedá RAL 7037	11,90	<b>14,28</b>	11,70	<b>14,04</b>	11,80	<b>14,16</b>	11,90	<b>14,28</b>	29,90	<b>35,88</b>
	076175		076199		076182		076205		076212	
<b>MM</b> 9 Metalická medená RAL extra	11,90	<b>14,28</b>	11,70	<b>14,04</b>	11,80	<b>14,16</b>	11,90	<b>14,28</b>	29,90	<b>35,88</b>
	075970		075987		075994		076007		076014	
<b>BHT – P.20</b> 10 Bielo hliníková tmavá RAL 9007			11,70	<b>14,04</b>	11,80	<b>14,16</b>	11,90	<b>14,28</b>	29,90	<b>35,88</b>
			094414		094421 *		094438		110688	
<b>MZ</b> 11 Machovo zelená RAL 6005	11,90	<b>14,28</b>	11,70	<b>14,04</b>	11,80	<b>14,16</b>	11,90	<b>14,28</b>	29,90	<b>35,88</b>
	076076		076083		076090		076106		076113	
<b>MOT</b> 12 Tmavo modrá RAL 5010	11,90	<b>14,28</b>	11,70	<b>14,04</b>	11,80	<b>14,16</b>	11,90	<b>14,28</b>	29,90	<b>35,88</b>
	076021 *		076038		076045		076052		076069	
<b>TZ</b> 13 Trávovo zelená RAL 6011	11,90	<b>14,28</b>	11,70	<b>14,04</b>	11,80	<b>14,16</b>	11,90	<b>14,28</b>	29,90	<b>35,88</b>
	076335 *		076328		076342		076359		076366 *	
<b>Balenie v ks</b> 📦	<b>5</b>		<b>5</b>		<b>5</b>		<b>5</b>		<b>5</b>	
<b>Balenie v ks</b> 🚚	<b>150</b>		<b>150</b>		<b>150</b>		<b>150</b>		<b>150</b>	

\* Výroba na objednávku



## ŽLABOVÉ ČELO POLKRUHOVÉ

P-PCL



Menovitá veľkosť	200		250		280		333		400	
	Bez DPH	S DPH	Bez DPH	S DPH	Bez DPH	S DPH	Bez DPH	S DPH	Bez DPH	S DPH
<b>TM</b> 1 Testa di Moro RAL 8028	1,45	1,74	1,30	1,56	1,40	1,68	1,45	1,74	2,25	2,70
	003164		003171		003188		003195		003201	
<b>AN</b> 2 Antracit RAL 7016	1,45	1,74	1,30	1,56	1,40	1,68	1,45	1,74	2,25	2,70
	002662		002679		002686		002693		002709	
<b>IC</b> 3 Intenzívna čierna RAL 9005	1,45	1,74	1,30	1,56	1,40	1,68	1,45	1,74	2,25	2,70
	002761		002778		002785		002792		002808	
<b>OC</b> 4 Oceľovo červená RAL 3009	1,45	1,74	1,30	1,56	1,40	1,68	1,45	1,74	2,25	2,70
	003010		003027		003034		003041		003058	
<b>MH</b> 5 Medeno hnedá RAL 8004	1,45	1,74	1,30	1,56	1,40	1,68	1,45	1,74	2,25	2,70
	002815		002822		002839		002846		002853	
<b>SB</b> 6 Šedo biela RAL 9002	1,45	1,74	1,30	1,56	1,40	1,68	1,45	1,74	2,25	2,70
	003119		003126		003133		003140		003157	
<b>BH</b> 7 Bielo hliníková RAL 9006	1,45	1,74	1,30	1,56	1,40	1,68	1,45	1,74	2,25	2,70
	002716		002723		002730		002747		002754	
<b>PS</b> 8 Prachovo šedá RAL 7037	1,45	1,74	1,30	1,56	1,40	1,68	1,45	1,74	2,25	2,70
	003065		003072		003089		003096		003102	
<b>MM</b> 9 Metalická medená RAL extra	1,45	1,74	1,30	1,56	1,40	1,68	1,45	1,74	2,25	2,70
	002860		002877		002884		002891		002907	
<b>BHT – P.20</b> 10 Bielo hliníková tmavá RAL 9007			1,30	1,56	1,40	1,68	1,45	1,74	2,25	2,70
			945680		094575 *		094582		094599	
<b>MZ</b> 11 Machovo zelená RAL 6005	1,45	1,74	1,30	1,56	1,40	1,68	1,45	1,74	2,25	2,70
	002969		002976		002983		002990		003003	
<b>MOT</b> 12 Tmavo modrá RAL 5010	1,45	1,74	1,30	1,56	1,40	1,68	1,45	1,74	2,25	2,70
	002914		002921		002938		002945		002952	
<b>TZ</b> 13 Trávovo zelená RAL 6011	1,45	1,74	1,30	1,56	1,40	1,68	1,45	1,74	2,25	2,70
	003218 *		003225		003232		003249		003256	
<b>Balenie v ks</b> 	<b>6/60</b>		<b>6/60</b>		<b>6/60</b>		<b>6/60</b>		<b>4/40</b>	
<b>Balenie v ks</b> 	<b>1 440</b>		<b>1 440</b>		<b>1 440</b>		<b>1 440</b>		<b>960</b>	

\* Výroba na objednávku



## ŽLABOVÉ ČELO S GUMOU

P-PCLG



Menovitá veľkosť	250		280		333	
	Bez DPH	S DPH	Bez DPH	S DPH	Bez DPH	S DPH
<b>TM</b> 1 Testa di Moro RAL 8028	2,65	<b>3,18</b>	2,90	<b>3,48</b>	3,00	<b>3,60</b>
	004338		004345		004352	
<b>AN</b> 2 Antracit RAL 7016	2,65	<b>3,18</b>	2,90	<b>3,48</b>	3,00	<b>3,60</b>
	004031		004048		004055	
<b>IC</b> 3 Intenzívna čierna RAL 9005	2,65	<b>3,18</b>	2,90	<b>3,48</b>	3,00	<b>3,60</b>
	004093		004109		004116	
<b>OC</b> 4 Oceľovo červená RAL 3009	2,65	<b>3,18</b>	2,90	<b>3,48</b>	3,00	<b>3,60</b>
	004246		004253		004260	
<b>MH</b> 5 Medeno hnedá RAL 8004	2,65	<b>3,18</b>	2,90	<b>3,48</b>	3,00	<b>3,60</b>
	004123		004130		004147	
<b>SB</b> 6 Šedo biela RAL 9002	2,65	<b>3,18</b>	2,90	<b>3,48</b>	3,00	<b>3,60</b>
	004307		004314		004321	
<b>BH</b> 7 Bielo hliníková RAL 9006	2,65	<b>3,18</b>	2,90	<b>3,48</b>	3,00	<b>3,60</b>
	004062		004079		004086	
<b>PS</b> 8 Prachovo šedá RAL 7037	2,65	<b>3,18</b>	2,90	<b>3,48</b>	3,00	<b>3,60</b>
	004277		004284		004291	
<b>MM</b> 9 Metalická medená RAL extra	2,65	<b>3,18</b>	2,90	<b>3,48</b>	3,00	<b>3,60</b>
	004154		004161		004178	
<b>BHT – P.20</b> 10 Bielo hliníková tmavá RAL 9007	2,65	<b>3,18</b>	2,90	<b>3,48</b>	3,00	<b>3,60</b>
	094605		094612 *		094629	
<b>MZ</b> 11 Machovo zelená RAL 6005	2,65	<b>3,18</b>	2,90	<b>3,48</b>	3,00	<b>3,60</b>
	004215		004222		004239	
<b>MOT</b> 12 Tmavo modrá RAL 5010	2,65	<b>3,18</b>	2,90	<b>3,48</b>	3,00	<b>3,60</b>
	004185		004192		004208	
<b>TZ</b> 13 Trávovo zelená RAL 6011	2,65	<b>3,18</b>	2,90	<b>3,48</b>	3,00	<b>3,60</b>
	004369 *		004376 *		004383 *	
<b>Balenie v ks</b> 	<b>4/40</b>		<b>4/40</b>		<b>4/40</b>	
<b>Balenie v ks</b> 	<b>960</b>		<b>960</b>		<b>960</b>	

\* Výroba na objednávku



## ŽLABOVÝ KOTLÍK

P-PKL

Menovitá veľkosť	200/60		250/60		250/80		280/80		280/100	
	Bez DPH	S DPH	Bez DPH	S DPH	Bez DPH	S DPH	Bez DPH	S DPH	Bez DPH	S DPH
<b>TM</b> 1 Testa di Moro RAL 8028	7,40	<b>8,88</b>	9,00	<b>10,80</b>	6,60	<b>7,92</b>	7,20	<b>8,64</b>	7,20	<b>8,64</b>
	067357		067364		067371		067388		067395	
<b>AN</b> 2 Antracit RAL 7016	7,40	<b>8,88</b>	9,00	<b>10,80</b>	6,60	<b>7,92</b>	7,20	<b>8,64</b>	7,20	<b>8,64</b>
	066251		066268		066275		066282		066299	
<b>IC</b> 3 Intenzívna čierna RAL 9005	7,40	<b>8,88</b>	9,00	<b>10,80</b>	6,60	<b>7,92</b>	7,20	<b>8,64</b>	7,20	<b>8,64</b>
	066473		066480		066497		066503		066510	
<b>OC</b> 4 Oceľovo červená RAL 3009	7,40	<b>8,88</b>	9,00	<b>10,80</b>	6,60	<b>7,92</b>	7,20	<b>8,64</b>	7,20	<b>8,64</b>
	067029		067036		067043		067050		067067	
<b>MH</b> 5 Medeno hnedá RAL 8004	7,40	<b>8,88</b>	9,00	<b>10,80</b>	6,60	<b>7,92</b>	7,20	<b>8,64</b>	7,20	<b>8,64</b>
	066589		066596		066602		066619		066626	
<b>SB</b> 6 Šedo biela RAL 9002	7,40	<b>8,88</b>	9,00	<b>10,80</b>	6,60	<b>7,92</b>	7,20	<b>8,64</b>	7,20	<b>8,64</b>
	067241		067258		067265		067272		067289	
<b>BH</b> 7 Bielo hliníková RAL 9006	7,40	<b>8,88</b>	9,00	<b>10,80</b>	6,60	<b>7,92</b>	7,20	<b>8,64</b>	7,20	<b>8,64</b>
	066367		066374		066381		066398		066404	
<b>PS</b> 8 Prachovo šedá RAL 7037	7,40	<b>8,88</b>	9,00	<b>10,80</b>	6,60	<b>7,92</b>	7,20	<b>8,64</b>	7,20	<b>8,64</b>
	067135		067142 *		067159		067166		067173	
<b>MM</b> 9 Metalická medená RAL extra	7,40	<b>8,88</b>	9,00	<b>10,80</b>	6,60	<b>7,92</b>	7,20	<b>8,64</b>	7,20	<b>8,64</b>
	066695		066701 *		066718		066725		066732	
<b>BHT – P.20</b> 10 Bielo hliníková tmavá RAL 9007	7,40	<b>8,88</b>	9,00	<b>10,80</b>	6,60	<b>7,92</b>	7,20	<b>8,64</b>	7,20	<b>8,64</b>
	119728 *		119735 *		094469		094476		094483	
<b>MZ</b> 11 Machovo zelená RAL 6005	7,40	<b>8,88</b>	9,00	<b>10,80</b>	6,60	<b>7,92</b>	7,20	<b>8,64</b>	7,20	<b>8,64</b>
	066916		066923		066930		066947		066954	
<b>MOT</b> 12 Tmavo modrá RAL 5010	7,40	<b>8,88</b>	9,00	<b>10,80</b>	6,60	<b>7,92</b>	7,20	<b>8,64</b>	7,20	<b>8,64</b>
	066800 *		066817 *		066824		066831		066848	
<b>TZ</b> 13 Trávovo zelená RAL 6011	7,40	<b>8,88</b>	9,00	<b>10,80</b>	6,60	<b>7,92</b>	7,20	<b>8,64</b>	7,20	<b>8,64</b>
	067463 *		067470 *		067487		067494 *		067500	
<b>Balenie v ks</b> 	<b>20</b>		<b>20</b>		<b>20</b>		<b>20</b>		<b>20</b>	
<b>Balenie v ks</b> 	<b>600</b>		<b>600</b>		<b>600</b>		<b>600</b>		<b>600</b>	

\* Výroba na objednávku



## ŽLABOVÝ KOTLÍK

P-PKL



Menovitá veľkosť	333/80		333/100		333/120	
	Bez DPH	S DPH	Bez DPH	S DPH	Bez DPH	S DPH
<b>TM</b> 1 Testa di Moro RAL 8028	8,40	<b>10,08</b>	7,95	<b>9,54</b>	9,50	<b>11,40</b>
	067401		067418		067425	
<b>AN</b> 2 Antracit RAL 7016	8,40	<b>10,08</b>	7,95	<b>9,54</b>	9,50	<b>11,40</b>
	066305		066312		066329	
<b>IC</b> 3 Intenzívna čierna RAL 9005	8,40	<b>10,08</b>	7,95	<b>9,54</b>	9,50	<b>11,40</b>
	066527		066534		066541	
<b>OC</b> 4 Oceľovo červená RAL 3009	8,40	<b>10,08</b>	7,95	<b>9,54</b>	9,50	<b>11,40</b>
	067074		067081		067098	
<b>MH</b> 5 Medeno hnedá RAL 8004	8,40	<b>10,08</b>	7,95	<b>9,54</b>	9,50	<b>11,40</b>
	066633		066640		066657	
<b>SB</b> 6 Šedo biela RAL 9002	8,40	<b>10,08</b>	7,95	<b>9,54</b>	9,50	<b>11,40</b>
	067296		067302		067326	
<b>BH</b> 7 Bielo hliníková RAL 9006	8,40	<b>10,08</b>	7,95	<b>9,54</b>	9,50	<b>11,40</b>
	066411		066428		066435	
<b>PS</b> 8 Prachovo šedá RAL 7037	8,40	<b>10,08</b>	7,95	<b>9,54</b>	9,50	<b>11,40</b>
	067180		067197		067203	
<b>MM</b> 9 Metalická medená RAL extra	8,40	<b>10,08</b>	7,95	<b>9,54</b>	9,50	<b>11,40</b>
	066749		066756		066763	
<b>BHT – P.20</b> 10 Bielo hliníková tmavá RAL 9007	8,40	<b>10,08</b>	7,95	<b>9,54</b>	9,50	<b>11,40</b>
	094490 *		094506		094513	
<b>MZ</b> 11 Machovo zelená RAL 6005	8,40	<b>10,08</b>	7,95	<b>9,54</b>	9,50	<b>11,40</b>
	066961		066978		066985	
<b>MOT</b> 12 Tmavo modrá RAL 5010	8,40	<b>10,08</b>	7,95	<b>9,54</b>	9,50	<b>11,40</b>
	066855 *		066862		066879	
<b>TZ</b> 13 Trávovo zelená RAL 6011	8,40	<b>10,08</b>	7,95	<b>9,54</b>	9,50	<b>11,40</b>
	067517 *		067524		067531	
<b>Balenie v ks</b> 	<b>20</b>		<b>20</b>		<b>15</b>	
<b>Balenie v ks</b> 	<b>600</b>		<b>600</b>		<b>300</b>	

\* Výroba na objednávku

## ŽLABOVÝ KOTLÍK

P-PKL

Menovitá veľkosť	400/100		400/120		400/150	
	Bez DPH	S DPH	Bez DPH	S DPH	Bez DPH	S DPH
<b>TM</b> 1 Testa di Moro RAL 8028	19,00	<b>22,80</b>	19,00	<b>22,80</b>	21,50	<b>25,80</b>
	067432		067449		067456	
<b>AN</b> 2 Antracit RAL 7016	19,00	<b>22,80</b>	19,00	<b>22,80</b>	21,50	<b>25,80</b>
	066336		066343		066350	
<b>IC</b> 3 Intenzívna čierna RAL 9005	19,00	<b>22,80</b>	19,00	<b>22,80</b>	21,50	<b>25,80</b>
	066558		066565		066572	
<b>OC</b> 4 Oceľovo červená RAL 3009	19,00	<b>22,80</b>	19,00	<b>22,80</b>	21,50	<b>25,80</b>
	067104 *		067111		067128	
<b>MH</b> 5 Medeno hnedá RAL 8004	19,00	<b>22,80</b>	19,00	<b>22,80</b>	21,50	<b>25,80</b>
	066664 *		066671		066688	
<b>SB</b> 6 Šedo biela RAL 9002	19,00	<b>22,80</b>	19,00	<b>22,80</b>	21,50	<b>25,80</b>
	067319		067333		067340	
<b>BH</b> 7 Bielo hliníková RAL 9006	19,00	<b>22,80</b>	19,00	<b>22,80</b>	21,50	<b>25,80</b>
	066442		066459		066466	
<b>PS</b> 8 Prachovo šedá RAL 7037	19,00	<b>22,80</b>	19,00	<b>22,80</b>	21,50	<b>25,80</b>
	067210		067227		067234	
<b>MM</b> 9 Metalická medená RAL extra	19,00	<b>22,80</b>	19,00	<b>22,80</b>	21,50	<b>25,80</b>
	066770 *		066787 *		066794 *	
<b>BHT – P.20</b> 10 Bielo hliníková tmavá RAL 9007	19,00	<b>22,80</b>	19,00	<b>22,80</b>	21,50	<b>25,80</b>
	119742 *		094520		094667	
<b>MZ</b> 11 Machovo zelená RAL 6005	19,00	<b>22,80</b>	19,00	<b>22,80</b>	21,50	<b>25,80</b>
	066992 *		067005		067012	
<b>MOT</b> 12 Tmavo modrá RAL 5010	19,00	<b>22,80</b>	19,00	<b>22,80</b>	21,50	<b>25,80</b>
	066886 *		066893		066909	
<b>TZ</b> 13 Trávovo zelená RAL 6011	19,00	<b>22,80</b>	19,00	<b>22,80</b>	21,50	<b>25,80</b>
	067548 *		067555		067562 *	
<b>Balenie v ks</b> 	<b>15</b>		<b>15</b>		<b>15</b>	
<b>Balenie v ks</b> 	<b>300</b>		<b>300</b>		<b>300</b>	

\* Výroba na objednávku



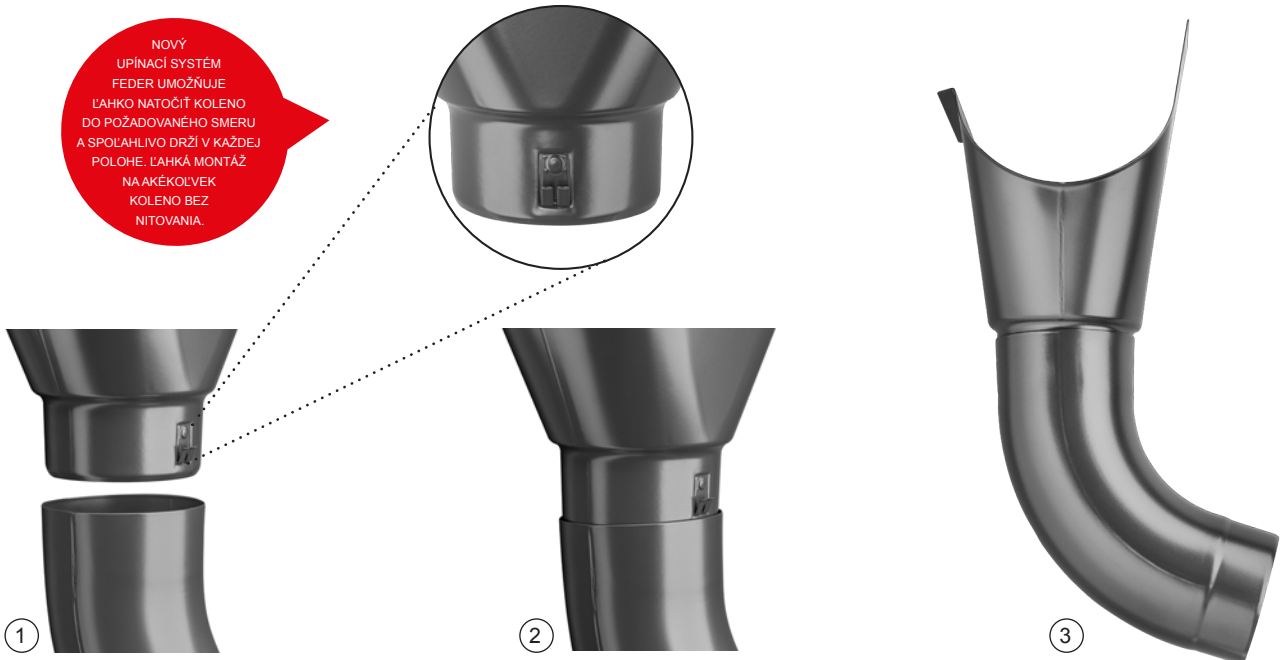

NOVÝ  
UPINACÍ SYSTÉM  
FEDER UMOŽŇUJE  
LAHKO NATOČIT KOLENO  
DO POŽADOVANÉHO SMERU  
A SPOLIAHLIVO DRŽÍ V KAŽDEJ  
POLOHE. LAHKÁ MONTÁŽ  
NA AKÉKOLVEK  
KOLENO BEZ  
NITOVANIA.



## STREŠNÉ ŽLABOVÉ HRDLO

P-PHRD

Menovitá veľkosť	80		100		120	
	Bez DPH	S DPH	Bez DPH	S DPH	Bez DPH	S DPH
<b>TM</b> 1 Testa di Moro RAL 8028	1,80	<b>2,16</b>	1,90	<b>2,28</b>	2,30	<b>2,76</b>
	066015		066022		066039	
<b>AN</b> 2 Antracit RAL 7016	1,80	<b>2,16</b>	1,90	<b>2,28</b>	2,30	<b>2,76</b>
	065711		065728		065735 *	
<b>IC</b> 3 Intenzívna čierna RAL 9005	1,80	<b>2,16</b>	1,90	<b>2,28</b>	2,30	<b>2,76</b>
	065773 *		065780		065797 *	
<b>OC</b> 4 Oceľovo červená RAL 3009	1,80	<b>2,16</b>	1,90	<b>2,28</b>	2,30	<b>2,76</b>
	065926 *		065933		065940 *	
<b>MH</b> 5 Medeno hnedá RAL 8004	1,80	<b>2,16</b>	1,90	<b>2,28</b>	2,30	<b>2,76</b>
	065803 *		065810		065827 *	
<b>SB</b> 6 Šedo biela RAL 9002	1,80	<b>2,16</b>	1,90	<b>2,28</b>	2,30	<b>2,76</b>
	065988 *		065995 *		066008 *	
<b>BH</b> 7 Bielo hliníková RAL 9006	1,80	<b>2,16</b>	1,90	<b>2,28</b>	2,30	<b>2,76</b>
	065742 *		065759 *		065766 *	
<b>PS</b> 8 Prachovo šedá RAL 7037	1,80	<b>2,16</b>	1,90	<b>2,28</b>	2,30	<b>2,76</b>
	065957 *		065964 *		065971 *	
<b>MM</b> 9 Metalická medená RAL extra	1,80	<b>2,16</b>	1,90	<b>2,28</b>	2,30	<b>2,76</b>
	065834 *		065841 *		065858 *	
<b>BHT – P.20</b> 10 Bielo hliníková tmavá RAL 9007						
<b>MZ</b> 11 Machovo zelená RAL 6005	1,80	<b>2,16</b>	1,90	<b>2,28</b>	2,30	<b>2,76</b>
	065896 *		065902 *		065919 *	
<b>MOT</b> 12 Tmavo modrá RAL 5010	1,80	<b>2,16</b>	1,90	<b>2,28</b>	2,30	<b>2,76</b>
	065865 *		065872 *		065889 *	
<b>TZ</b> 13 Trávovo zelená RAL 6011	1,80	<b>2,16</b>	1,90	<b>2,28</b>	2,30	<b>2,76</b>
	066046 *		066053 *		066060 *	
<b>Balenie v ks</b> 	<b>25</b>		<b>25</b>		<b>15</b>	
<b>Balenie v ks</b> 	<b>1 000</b>		<b>1 000</b>		<b>750</b>	

\* Výroba na objednávku







**NEREZOVÝ ZACHYTÁVAČ NEČISTÔT STREŠNÝCH ŽLABOV**

**N-NZN**



Menovitá veľkosť	EAN číslo výrobku	Balenie v ks		Cena [€/ks]	
				Bez DPH	S DPH
<b>60</b>	001153	30	2 160	5,55	<b>6,66</b>
<b>80</b>	001160	20	1 440	5,60	<b>6,72</b>
<b>100</b>	001177	15	1 080	5,70	<b>6,84</b>
<b>120</b>	001184	10	720	6,20	<b>7,44</b>
<b>150</b>	001191	5	360	9,80	<b>11,76</b>



## KOTLÍK ZBERNÝ DESIGN

## P-PKLZ DE

Menovitá veľkosť	80		100		120	
	Bez DPH	S DPH	Bez DPH	S DPH	Bez DPH	S DPH
<b>TM</b> 1 Testa di Moro RAL 8028	58,00	<b>69,60</b>	58,00	<b>69,60</b>	64,00	<b>76,80</b>
	027702		027726		027740	
<b>AN</b> 2 Antracit RAL 7016	58,00	<b>69,60</b>	58,00	<b>69,60</b>	64,00	<b>76,80</b>
	026200		026224		026248	
<b>IC</b> 3 Intenzívna čierna RAL 9005	58,00	<b>69,60</b>	58,00	<b>69,60</b>	64,00	<b>76,80</b>
	026507		026521		026545	
<b>OC</b> 4 Oceľovo červená RAL 3009	58,00	<b>69,60</b>	58,00	<b>69,60</b>	64,00	<b>76,80</b>
	027252 *		027276		027290	
<b>MH</b> 5 Medeno hnedá RAL 8004	58,00	<b>69,60</b>	58,00	<b>69,60</b>	64,00	<b>76,80</b>
	026651		026675		026699	
<b>SB</b> 6 Šedo biela RAL 9002	58,00	<b>69,60</b>	58,00	<b>69,60</b>	64,00	<b>76,80</b>
	027559 *		027573		027597	
<b>BH</b> 7 Bielo hliníková RAL 9006	58,00	<b>69,60</b>	58,00	<b>69,60</b>	64,00	<b>76,80</b>
	026354		026378		026392	
<b>PS</b> 8 Prachovo šedá RAL 7037	58,00	<b>69,60</b>	58,00	<b>69,60</b>	64,00	<b>76,80</b>
	027405		027429		027443	
<b>MM</b> 9 Metalická medená RAL extra	58,00	<b>69,60</b>	58,00	<b>69,60</b>	64,00	<b>76,80</b>
	026804 *		026828		026842	
<b>BHT – P.20</b> 10 Bielo hliníková tmavá RAL 9007	58,00	<b>69,60</b>	58,00	<b>69,60</b>	64,00	<b>76,80</b>
	096210		096265		096319	
<b>MZ</b> 11 Machovo zelená RAL 6005	58,00	<b>69,60</b>	58,00	<b>69,60</b>	64,00	<b>76,80</b>
	027108 *		027122		027146 *	
<b>MOT</b> 12 Tmavo modrá RAL 5010	58,00	<b>69,60</b>	58,00	<b>69,60</b>	64,00	<b>76,80</b>
	026958 *		026972		027009 *	
<b>TZ</b> 13 Trávovo zelená RAL 6011	58,00	<b>69,60</b>	58,00	<b>69,60</b>	64,00	<b>76,80</b>
	027856 *		027870 *		027894 *	
<b>Balenie v ks</b> 	<b>2</b>		<b>2</b>		<b>2</b>	
<b>Balenie v ks</b> 	<b>36</b>		<b>36</b>		<b>36</b>	

\* Výroba na objednávku



### KOTLÍK ZBERNÝ DESING EXZENTRICKÝ

### P-PKLZ DX



Menovitá veľkosť	80		100		120	
	Bez DPH	S DPH	Bez DPH	S DPH	Bez DPH	S DPH
<b>TM</b> 1 Testa di Moro RAL 8028	72,00	<b>86,40</b>	72,00	<b>86,40</b>	74,00	<b>88,80</b>
	027764		027795		027825	
<b>AN</b> 2 Antracit RAL 7016	72,00	<b>86,40</b>	72,00	<b>86,40</b>	74,00	<b>88,80</b>
	026262		026293		026323	
<b>IC</b> 3 Intenzívna čierna RAL 9005	72,00	<b>86,40</b>	72,00	<b>86,40</b>	74,00	<b>88,80</b>
	026569		026590		026620 *	
<b>OC</b> 4 Oceľovo červená RAL 3009	72,00	<b>86,40</b>	72,00	<b>86,40</b>	74,00	<b>88,80</b>
	027313		027344		027375 *	
<b>MH</b> 5 Medeno hnedá RAL 8004	72,00	<b>86,40</b>	72,00	<b>86,40</b>	74,00	<b>88,80</b>
	026712 *		026743 *		026774 *	
<b>SB</b> 6 Šedo biela RAL 9002	72,00	<b>86,40</b>	72,00	<b>86,40</b>	74,00	<b>88,80</b>
	027610 *		027641		027672	
<b>BH</b> 7 Bielo hliníková RAL 9006	72,00	<b>86,40</b>	72,00	<b>86,40</b>	74,00	<b>88,80</b>
	026415 *		026446		026477	
<b>PS</b> 8 Prachovo šedá RAL 7037	72,00	<b>86,40</b>	72,00	<b>86,40</b>	74,00	<b>88,80</b>
	027467 *		027498		027528	
<b>MM</b> 9 Metalická medená RAL extra	72,00	<b>86,40</b>	72,00	<b>86,40</b>	74,00	<b>88,80</b>
	026866 *		026897		026927 *	
<b>BHT – P.20</b> 10 Bielo hliníková tmavá RAL 9007	72,00	<b>86,40</b>	72,00	<b>86,40</b>	74,00	<b>88,80</b>
	096203 *		096258		096302	
<b>MZ</b> 11 Machovo zelená RAL 6005	72,00	<b>86,40</b>	72,00	<b>86,40</b>	74,00	<b>88,80</b>
	027160 *		027191 *		027221 *	
<b>MOT</b> 12 Tmavo modrá RAL 5010	72,00	<b>86,40</b>	72,00	<b>86,40</b>	74,00	<b>88,80</b>
	027016 *		027047 *		027078 *	
<b>TZ</b> 13 Trávovo zelená RAL 6011	72,00	<b>86,40</b>	72,00	<b>86,40</b>	74,00	<b>88,80</b>
	027917 *		027948 *		027979 *	
<b>Balenie v ks</b> 	<b>2</b>		<b>2</b>		<b>2</b>	
<b>Balenie v ks</b> 	<b>36</b>		<b>36</b>		<b>36</b>	

\* Výroba na objednávku

## KOTLÍK ZBERNÝ KUBICKÝ

## P-PKLZ KU



Menovitá veľkosť	80		100		120	
	Bez DPH	S DPH	Bez DPH	S DPH	Bez DPH	S DPH
<b>TM</b> 1 Testa di Moro RAL 8028	88,00	<b>105,60</b>	88,00	<b>105,60</b>	94,00	<b>112,80</b>
	027719 *		027733		027757	
<b>AN</b> 2 Antracit RAL 7016	88,00	<b>105,60</b>	88,00	<b>105,60</b>	94,00	<b>112,80</b>
	026217		026231		026255	
<b>IC</b> 3 Intenzívna čierna RAL 9005	88,00	<b>105,60</b>	88,00	<b>105,60</b>	94,00	<b>112,80</b>
	026514		026538		026552	
<b>OC</b> 4 Oceľovo červená RAL 3009	88,00	<b>105,60</b>	88,00	<b>105,60</b>	94,00	<b>112,80</b>
	027269 *		027283 *		027306	
<b>MH</b> 5 Medeno hnedá RAL 8004	88,00	<b>105,60</b>	88,00	<b>105,60</b>	94,00	<b>112,80</b>
	026668 *		026682 *		026705 *	
<b>SB</b> 6 Šedo biela RAL 9002	88,00	<b>105,60</b>	88,00	<b>105,60</b>	94,00	<b>112,80</b>
	027566 *		027580 *		027603 *	
<b>BH</b> 7 Bielo hliníková RAL 9006	88,00	<b>105,60</b>	88,00	<b>105,60</b>	94,00	<b>112,80</b>
	026361 *		026385 *		026408	
<b>PS</b> 8 Prachovo šedá RAL 7037	88,00	<b>105,60</b>	88,00	<b>105,60</b>	94,00	<b>112,80</b>
	027412 *		027436 *		027450	
<b>MM</b> 9 Metalická medená RAL extra	88,00	<b>105,60</b>	88,00	<b>105,60</b>	94,00	<b>112,80</b>
	026811 *		026835 *		026859 *	
<b>BHT – P.20</b> 10 Bielo hliníková tmavá RAL 9007	88,00	<b>105,60</b>	88,00	<b>105,60</b>	94,00	<b>112,80</b>
	096241 *		096296		096340 *	
<b>MZ</b> 11 Machovo zelená RAL 6005	88,00	<b>105,60</b>	88,00	<b>105,60</b>	94,00	<b>112,80</b>
	027115 *		027139 *		027153 *	
<b>MOT</b> 12 Tmavo modrá RAL 5010	88,00	<b>105,60</b>	88,00	<b>105,60</b>	94,00	<b>112,80</b>
	026965 *		026989 *		026996 *	
<b>TZ</b> 13 Trávovo zelená RAL 6011	88,00	<b>105,60</b>	88,00	<b>105,60</b>	94,00	<b>112,80</b>
	027863 *		027887 *		027900 *	
<b>Balenie v ks</b> 	<b>2</b>		<b>2</b>		<b>2</b>	
<b>Balenie v ks</b> 	<b>36</b>		<b>36</b>		<b>36</b>	

\* Výroba na objednávku

## KOTLÍK ZBERNÝ KUBICKÝ EXZENTRICKÝ

P-PKLZ KX



Menovitá veľkosť	80		100		120	
	Bez DPH	S DPH	Bez DPH	S DPH	Bez DPH	S DPH
<b>TM</b> 1 Testa di Moro RAL 8028	88,00	<b>105,60</b>	88,00	<b>105,60</b>	94,00	<b>112,80</b>
	027788		027818		027849	
<b>AN</b> 2 Antracit RAL 7016	88,00	<b>105,60</b>	88,00	<b>105,60</b>	94,00	<b>112,80</b>
	026286		026316		026347	
<b>IC</b> 3 Intenzívna čierna RAL 9005	88,00	<b>105,60</b>	88,00	<b>105,60</b>	94,00	<b>112,80</b>
	026583		026613		026644 *	
<b>OC</b> 4 Oceľovo červená RAL 3009	88,00	<b>105,60</b>	88,00	<b>105,60</b>	94,00	<b>112,80</b>
	027337 *		027368		027399	
<b>MH</b> 5 Medeno hnedá RAL 8004	88,00	<b>105,60</b>	88,00	<b>105,60</b>	94,00	<b>112,80</b>
	026736		026767		026798 *	
<b>SB</b> 6 Šedo biela RAL 9002	88,00	<b>105,60</b>	88,00	<b>105,60</b>	94,00	<b>112,80</b>
	027634 *		027665		027696	
<b>BH</b> 7 Bielo hliníková RAL 9006	88,00	<b>105,60</b>	88,00	<b>105,60</b>	94,00	<b>112,80</b>
	026439 *		026460		026491	
<b>PS</b> 8 Prachovo šedá RAL 7037	88,00	<b>105,60</b>	88,00	<b>105,60</b>	94,00	<b>112,80</b>
	027481 *		027511		027542	
<b>MM</b> 9 Metalická medená RAL extra	88,00	<b>105,60</b>	88,00	<b>105,60</b>	94,00	<b>112,80</b>
	026880 *		026910		026941 *	
<b>BHT – P.20</b> 10 Bielo hliníková tmavá RAL 9007	88,00	<b>105,60</b>	88,00	<b>105,60</b>	94,00	<b>112,80</b>
	096227		096272		096326	
<b>MZ</b> 11 Machovo zelená RAL 6005	88,00	<b>105,60</b>	88,00	<b>105,60</b>	94,00	<b>112,80</b>
	027184 *		027214		027245 *	
<b>MOT</b> 12 Tmavo modrá RAL 5010	88,00	<b>105,60</b>	88,00	<b>105,60</b>	94,00	<b>112,80</b>
	027030 *		027061 *		027092 *	
<b>TZ</b> 13 Trávovo zelená RAL 6011	88,00	<b>105,60</b>	88,00	<b>105,60</b>	94,00	<b>112,80</b>
	027931 *		027962		027993 *	
<b>Balenie v ks</b> 📦	<b>2</b>		<b>2</b>		<b>2</b>	
<b>Balenie v ks</b> 🚚	<b>36</b>		<b>36</b>		<b>36</b>	

\* Výroba na objednávku

### KOTLÍK ZBERNÝ KUBICKÝ EXZENTRICKÝ VÝTOK

P-PKLZ KXV



Menovitá veľkosť	80		100		120	
	Bez DPH	S DPH	Bez DPH	S DPH	Bez DPH	S DPH
<b>TM</b> 1 Testa di Moro RAL 8028	115,00	<b>138,00</b>	115,00	<b>138,00</b>	115,00	<b>138,00</b>
	027771 *		027801 *		027832 *	
<b>AN</b> 2 Antracit RAL 7016	115,00	<b>138,00</b>	115,00	<b>138,00</b>	115,00	<b>138,00</b>
	026279 *		026309 *		026330 *	
<b>IC</b> 3 Intenzívna čierna RAL 9005	115,00	<b>138,00</b>	115,00	<b>138,00</b>	115,00	<b>138,00</b>
	026576 *		026606		026637 *	
<b>OC</b> 4 Oceľovo červená RAL 3009	115,00	<b>138,00</b>	115,00	<b>138,00</b>	115,00	<b>138,00</b>
	027320 *		027351 *		027382 *	
<b>MH</b> 5 Medeno hnedá RAL 8004	115,00	<b>138,00</b>	115,00	<b>138,00</b>	115,00	<b>138,00</b>
	026729 *		026750 *		026781 *	
<b>SB</b> 6 Šedo biela RAL 9002	115,00	<b>138,00</b>	115,00	<b>138,00</b>	115,00	<b>138,00</b>
	027627 *		027658 *		027689 *	
<b>BH</b> 7 Bielo hliníková RAL 9006	115,00	<b>138,00</b>	115,00	<b>138,00</b>	115,00	<b>138,00</b>
	026422 *		026453 *		026484 *	
<b>PS</b> 8 Prachovo šedá RAL 7037	115,00	<b>138,00</b>	115,00	<b>138,00</b>	115,00	<b>138,00</b>
	027474 *		027504 *		027535 *	
<b>MM</b> 9 Metalická medená RAL extra	115,00	<b>138,00</b>	115,00	<b>138,00</b>	115,00	<b>138,00</b>
	026873 *		026903 *		026934 *	
<b>BHT – P.20</b> 10 Bielo hliníková tmavá RAL 9007	115,00	<b>138,00</b>	115,00	<b>138,00</b>	115,00	<b>138,00</b>
	096234 *		096289 *		096333 *	
<b>MZ</b> 11 Machovo zelená RAL 6005	115,00	<b>138,00</b>	115,00	<b>138,00</b>	115,00	<b>138,00</b>
	027177 *		027207 *		027238 *	
<b>MOT</b> 12 Tmavo modrá RAL 5010	115,00	<b>138,00</b>	115,00	<b>138,00</b>	115,00	<b>138,00</b>
	027023 *		027054 *		027085 *	
<b>TZ</b> 13 Trávovo zelená RAL 6011	115,00	<b>138,00</b>	115,00	<b>138,00</b>	115,00	<b>138,00</b>
	027924 *		027955 *		027986 *	
<b>Balenie v ks</b> 	<b>2</b>		<b>2</b>		<b>2</b>	
<b>Balenie v ks</b> 	<b>36</b>		<b>36</b>		<b>36</b>	

\* Výroba na objednávku

**EPDM TESNIACA GUMA ZBERNÉHO KOTLIČKA**

**P-PKLZ T**



Menovitá veľkosť	EAN číslo výrobku	Balenie v ks		Cena [€/ks]	
				Bez DPH	S DPH
<b>IC 70-85</b>	077103	5	600	3,90	<b>4,68</b>
<b>IC 100-110</b>	077110	5	600	4,00	<b>4,80</b>
<b>IC 110-125</b>	077097	5	600	4,10	<b>4,92</b>
<b>PS 70-85</b>	077134	5	600	4,30	<b>5,16</b>
<b>PS 100-110</b>	077141	5	600	4,75	<b>5,70</b>
<b>PS 110-125</b>	077127	5	600	4,90	<b>5,88</b>

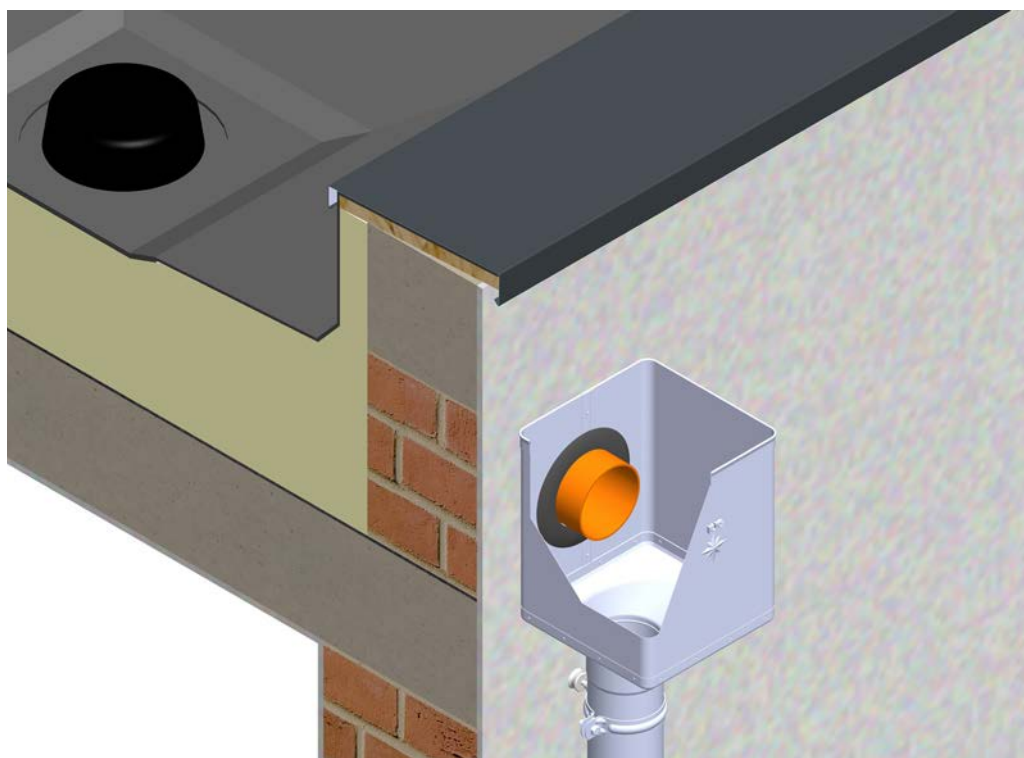

## ZVODOVÉ KOLENO 72°

P-PK

Menovitá veľkosť	60		80		100		120		150	
	Bez DPH	S DPH	Bez DPH	S DPH	Bez DPH	S DPH	Bez DPH	S DPH	Bez DPH	S DPH
<b>TM</b> 1 Testa di Moro RAL 8028	7,00	<b>8,40</b>	6,40	<b>7,68</b>	7,90	<b>9,48</b>	9,55	<b>11,46</b>	21,00	<b>25,20</b>
	072542		072559		072573		072597		033697	
<b>AN</b> 2 Antracit RAL 7016	7,00	<b>8,40</b>	6,40	<b>7,68</b>	7,90	<b>9,48</b>	9,55	<b>11,46</b>	21,00	<b>25,20</b>
	071842		071859		071873		071897		033598	
<b>IC</b> 3 Intenzívna čierna RAL 9005	7,00	<b>8,40</b>	6,40	<b>7,68</b>	7,90	<b>9,48</b>	9,55	<b>11,46</b>	21,00	<b>25,20</b>
	071989		072023		072009		072030		033611	
<b>OC</b> 4 Oceľovo červená RAL 3009	7,00	<b>8,40</b>	6,40	<b>7,68</b>	7,90	<b>9,48</b>	9,55	<b>11,46</b>	21,00	<b>25,20</b>
	072337		072344		072368		072382		033666	
<b>MH</b> 5 Medeno hnedá RAL 8004	7,00	<b>8,40</b>	6,40	<b>7,68</b>	7,90	<b>9,48</b>	9,55	<b>11,46</b>	21,00	<b>25,20</b>
	072054		072061		072085		072108		033628	
<b>SB</b> 6 Šedo biela RAL 9002	7,00	<b>8,40</b>	6,40	<b>7,68</b>	7,90	<b>9,48</b>	9,55	<b>11,46</b>	21,00	<b>25,20</b>
	072474		072481		072504		072528		033680	
<b>BH</b> 7 Bielo hliníková RAL 9006	7,00	<b>8,40</b>	6,40	<b>7,68</b>	7,90	<b>9,48</b>	9,55	<b>11,46</b>	21,00	<b>25,20</b>
	071910		071927		071941		071965		033604	
<b>PS</b> 8 Prachovo šedá RAL 7037	7,00	<b>8,40</b>	6,40	<b>7,68</b>	7,90	<b>9,48</b>	9,55	<b>11,46</b>	21,00	<b>25,20</b>
	072405		072412		072429		072443		033673	
<b>MM</b> 9 Metalická medená RAL extra	7,00	<b>8,40</b>	6,40	<b>7,68</b>	7,90	<b>9,48</b>	9,55	<b>11,46</b>	21,00	<b>25,20</b>
	072122		072139		072153		072160		033635	
<b>BHT – P.20</b> 10 Bielo hliníková tmavá RAL 9007	7,00	<b>8,40</b>	6,40	<b>7,68</b>	7,90	<b>9,48</b>	9,55	<b>11,46</b>	21,00	<b>25,20</b>
	118691		095183		095206		095220		095244	
<b>MZ</b> 11 Machovo zelená RAL 6005	7,00	<b>8,40</b>	6,40	<b>7,68</b>	7,90	<b>9,48</b>	9,55	<b>11,46</b>	21,00	<b>25,20</b>
	072269		072276		072290		072313		033659	
<b>MOT</b> 12 Tmavo modrá RAL 5010	7,00	<b>8,40</b>	6,40	<b>7,68</b>	7,90	<b>9,48</b>	9,55	<b>11,46</b>	21,00	<b>25,20</b>
	072191		072207		072221		072245		033642	
<b>TZ</b> 13 Trávovo zelená RAL 6011	7,00	<b>8,40</b>	6,40	<b>7,68</b>	7,90	<b>9,48</b>	9,55	<b>11,46</b>	21,00	<b>25,20</b>
	072610 *		072627		072641		072665		033703 *	
<b>Balenie v ks</b> 📦	<b>25</b>		<b>25</b>		<b>25</b>		<b>15</b>		<b>5</b>	
<b>Balenie v ks</b> 🚚	<b>600</b>		<b>400</b>		<b>300</b>		<b>180</b>		<b>90</b>	

\* Výroba na objednávku





## ZVODOVÉ KOLENO RÁDIUS 85°

P-PKR

Menovitá veľkosť	80		100		120	
	Bez DPH	S DPH	Bez DPH	S DPH	Bez DPH	S DPH
<b>TM</b> 1 Testa di Moro RAL 8028	7,50	<b>9,00</b>	8,50	<b>10,20</b>	13,90	<b>16,68</b>
	072566		072580		072603	
<b>AN</b> 2 Antracit RAL 7016	7,50	<b>9,00</b>	8,50	<b>10,20</b>	13,90	<b>16,68</b>
	071866		071880		071903	
<b>IC</b> 3 Intenzívna čierna RAL 9005	7,50	<b>9,00</b>	8,50	<b>10,20</b>	13,90	<b>16,68</b>
	071996		072016		072047	
<b>OC</b> 4 Oceľovo červená RAL 3009	7,50	<b>9,00</b>	8,50	<b>10,20</b>	13,90	<b>16,68</b>
	072351		072375		072399	
<b>MH</b> 5 Medeno hnedá RAL 8004	7,50	<b>9,00</b>	8,50	<b>10,20</b>	13,90	<b>16,68</b>
	072078		072092		072115	
<b>SB</b> 6 Šedo biela RAL 9002	7,50	<b>9,00</b>	8,50	<b>10,20</b>	13,90	<b>16,68</b>
	072498		072511		072535	
<b>BH</b> 7 Bielo hliníková RAL 9006	7,50	<b>9,00</b>	8,50	<b>10,20</b>	13,90	<b>16,68</b>
	071934		071958		071972	
<b>PS</b> 8 Prachovo šedá RAL 7037	7,50	<b>9,00</b>	8,50	<b>10,20</b>	13,90	<b>16,68</b>
	072467		072436		072450	
<b>MM</b> 9 Metalická medená RAL extra	7,50	<b>9,00</b>	8,50	<b>10,20</b>	13,90	<b>16,68</b>
	072146		072184		072177	
<b>BHT – P.20</b> 10 Bielo hliníková tmavá RAL 9007	7,50	<b>9,00</b>	8,50	<b>10,20</b>	13,90	<b>16,68</b>
	095190		095213		095237 *	
<b>MZ</b> 11 Machovo zelená RAL 6005	7,50	<b>9,00</b>	8,50	<b>10,20</b>	13,90	<b>16,68</b>
	072283		072306		072320	
<b>MOT</b> 12 Tmavo modrá RAL 5010	7,50	<b>9,00</b>	8,50	<b>10,20</b>	13,90	<b>16,68</b>
	072214 *		072238 *		072252 *	
<b>TZ</b> 13 Trávovo zelená RAL 6011	7,50	<b>9,00</b>	8,50	<b>10,20</b>	13,90	<b>16,68</b>
	072634 *		072658 *		072672 *	
<b>Balenie v ks</b> 	<b>25</b>		<b>25</b>		<b>15</b>	
<b>Balenie v ks</b> 	<b>400</b>		<b>300</b>		<b>180</b>	

\* Výroba na objednávku



## ZVODOVÉ KOLENO TUPÉ 40°

P-PKT

Menovitá veľkosť	80		100		120	
	Bez DPH	S DPH	Bez DPH	S DPH	Bez DPH	S DPH
<b>TM</b> 1 Testa di Moro RAL 8028	7,10	8,52	7,80	9,36	11,20	13,44
	072993		073006		073013	
<b>AN</b> 2 Antracit RAL 7016	7,10	8,52	7,80	9,36	11,20	13,44
	072696		072702		072719	
<b>IC</b> 3 Intenzívna čierna RAL 9005	7,10	8,52	7,80	9,36	11,20	13,44
	072757		072764		072771	
<b>OC</b> 4 Oceľovo červená RAL 3009	7,10	8,52	7,80	9,36	11,20	13,44
	072900		072917		072924	
<b>MH</b> 5 Medeno hnedá RAL 8004	7,10	8,52	7,80	9,36	11,20	13,44
	072795		072788		072801	
<b>SB</b> 6 Šedo biela RAL 9002	7,10	8,52	7,80	9,36	11,20	13,44
	072962		072979		072986	
<b>BH</b> 7 Bielo hliníková RAL 9006	7,10	8,52	7,80	9,36	11,20	13,44
	072726		072733		072740	
<b>PS</b> 8 Prachovo šedá RAL 7037	7,10	8,52	7,80	9,36	11,20	13,44
	072931		072948		072955	
<b>MM</b> 9 Metalická medená RAL extra	7,10	8,52	7,80	9,36	11,20	13,44
	072818		072825		072832 *	
<b>BHT – P.20</b> 10 Bielo hliníková tmavá RAL 9007	7,10	8,52	7,80	9,36	11,20	13,44
	094711		094728		094735	
<b>MZ</b> 11 Machovo zelená RAL 6005	7,10	8,52	7,80	9,36	11,20	13,44
	072870 *		072887		072894	
<b>MOT</b> 12 Tmavo modrá RAL 5010	7,10	8,52	7,80	9,36	11,20	13,44
	072849		072856		072863	
<b>TZ</b> 13 Trávovo zelená RAL 6011	7,10	8,52	7,80	9,36	11,20	13,44
	073020 *		073037 *		073044 *	
<b>Balenie v ks</b> 📦	25		25		15	
<b>Balenie v ks</b> 🚚	400		300		240	

\* Výroba na objednávku



## KOLENO VÝTOKOVÉ ZIGNA 72°

P-PKV



Menovitá veľkosť	80		100		120	
	Bez DPH	S DPH	Bez DPH	S DPH	Bez DPH	S DPH
<b>TM</b> 1 Testa di Moro RAL 8028	7,40	<b>8,88</b>	8,90	<b>10,68</b>	10,55	<b>12,66</b>
	095046		095053		095060	
<b>AN</b> 2 Antracit RAL 7016	7,40	<b>8,88</b>	8,90	<b>10,68</b>	10,55	<b>12,66</b>
	094742		094759		094766	
<b>IC</b> 3 Intenzívna čierna RAL 9005	7,40	<b>8,88</b>	8,90	<b>10,68</b>	10,55	<b>12,66</b>
	094803		094810		094827 *	
<b>OC</b> 4 Oceľovo červená RAL 3009	7,40	<b>8,88</b>	8,90	<b>10,68</b>	10,55	<b>12,66</b>
	094957 *		094964		094971 *	
<b>MH</b> 5 Medeno hnedá RAL 8004	7,40	<b>8,88</b>	8,90	<b>10,68</b>	10,55	<b>12,66</b>
	094834		094841		094858	
<b>SB</b> 6 Šedo biela RAL 9002	7,40	<b>8,88</b>	8,90	<b>10,68</b>	10,55	<b>12,66</b>
	095015 *		095022		095039	
<b>BH</b> 7 Bielo hliníková RAL 9006	7,40	<b>8,88</b>	8,90	<b>10,68</b>	10,55	<b>12,66</b>
	094773 *		094780		094797	
<b>PS</b> 8 Prachovo šedá RAL 7037	7,40	<b>8,88</b>	8,90	<b>10,68</b>	10,55	<b>12,66</b>
	094988 *		094995 *		095008 *	
<b>MM</b> 9 Metalická medená RAL extra	7,40	<b>8,88</b>	8,90	<b>10,68</b>	10,55	<b>12,66</b>
	094865 *		094872 *		094889 *	
<b>BHT – P.20</b> 10 Bielo hliníková tmavá RAL 9007	7,40	<b>8,88</b>	8,90	<b>10,68</b>	10,55	<b>12,66</b>
	124739 *		124746 *		124753 *	
<b>MZ</b> 11 Machovo zelená RAL 6005	7,40	<b>8,88</b>	8,90	<b>10,68</b>	10,55	<b>12,66</b>
	094926 *		094933 *		094940 *	
<b>MOT</b> 12 Tmavo modrá RAL 5010	7,40	<b>8,88</b>	8,90	<b>10,68</b>	10,55	<b>12,66</b>
	094896 *		094902 *		094919 *	
<b>TZ</b> 13 Trávovo zelená RAL 6011	7,40	<b>8,88</b>	8,90	<b>10,68</b>	10,55	<b>12,66</b>
	095077 *		095084 *		095091 *	
<b>Balenie v ks</b> 📦	<b>25</b>		<b>25</b>		<b>15</b>	
<b>Balenie v ks</b> 🚚	<b>400</b>		<b>300</b>		<b>180</b>	

\* Výroba na objednávku

## KOLENO FALCOVANÉ 72°

P-PKF2



Menovitá veľkosť	60		80		100		120	
Cena v €/ks	Bez DPH	S DPH	Bez DPH	S DPH	Bez DPH	S DPH	Bez DPH	S DPH
<b>TM</b> 1 Testa di Moro RAL 8028	4,30	<b>5,16</b>	3,40	<b>4,08</b>	4,40	<b>5,28</b>	6,30	<b>7,56</b>
	071781		071798		071811		071828	
Balenie v ks	10		10		10		8	
Balenie v ks	3 000		1 200		1 000		576	

## KOLENO FALCOVANÉ 85°

P-PKF3



Menovitá veľkosť	80		100	
Cena v €/ks	Bez DPH	S DPH	Bez DPH	S DPH
<b>TM</b> 1 Testa di Moro RAL 8028	4,40	<b>5,28</b>	6,30	<b>7,56</b>
	071804		071835	
Balenie v ks	10		10	
Balenie v ks	1 200		800	

## KOMÍNOVÉ OPLECHOVANIE

SD-KOMIN OPLE



Menovitá veľkosť	1A 18-30 cm		2A 30-58 cm		3A 58-82 cm	
Cena v €/ks	Bez DPH	S DPH	Bez DPH	S DPH	Bez DPH	S DPH
<b>TM</b> 1 Testa di Moro RAL 8028	29,00	<b>34,80</b>	35,00	<b>42,00</b>	40,50	<b>48,60</b>
	096753		096760		096777	
Balenie v ks	5		5		5	
Balenie v ks	105		60		50	

## PLASTOVÝ ZVODOVÝ RUKÁV

SD-ZR FOLIA KJG



Menovitá veľkosť	Dĺžka v m	EAN číslo výrobku	Balenie v m		Cena [€/ks]	
					Bez DPH	S DPH
60 – 150	100,0	139726	100	6 000	0,38	<b>0,46</b>

**ZVODOVÁ RÚRA [s=0,55]**
**P-PZR**

Menovitá veľkosť	60		60		80		80		80		
	2,0		3,0		1,0		2,0		3,0		
Dĺžka v m	2,0		3,0		1,0		2,0		3,0		
	Bez DPH	S DPH	Bez DPH	S DPH	Bez DPH	S DPH	Bez DPH	S DPH	Bez DPH	S DPH	
<b>TM</b> Testa di Moro RAL 8028	1	8,90	<b>10,68</b>	8,90	<b>10,68</b>	8,00	<b>9,60</b>	8,00	<b>9,60</b>	7,80	<b>9,36</b>
		071309		071316		071323		071330		071347	
<b>AN</b> Antracit RAL 7016	2	8,90	<b>10,68</b>	8,90	<b>10,68</b>	8,00	<b>9,60</b>	8,00	<b>9,60</b>	7,80	<b>9,36</b>
		069467		069474		069481		069498		069504	
<b>IC</b> Intenzívna čierna RAL 9005	3	8,90	<b>10,68</b>	8,90	<b>10,68</b>	8,00	<b>9,60</b>	8,00	<b>9,60</b>	7,80	<b>9,36</b>
		069900		069917		069924		069931		069948	
<b>OC</b> Oceľovo červená RAL 3009	4	8,90	<b>10,68</b>	8,90	<b>10,68</b>	8,00	<b>9,60</b>	8,00	<b>9,60</b>	7,80	<b>9,36</b>
		070661		070678		070685		070692		070708	
<b>MH</b> Medeno hnedá RAL 8004	5	9,00	<b>10,80</b>			8,10	<b>9,72</b>	8,10	<b>9,72</b>	7,90	<b>9,48</b>
		070128				070142		070159		070166	
<b>SB</b> Šedo biela RAL 9002	6	9,00	<b>10,80</b>	9,00	<b>10,80</b>	8,10	<b>9,72</b>	8,10	<b>9,72</b>	7,90	<b>9,48</b>
		071088		071095		071101		071118		071125	
<b>BH</b> Bielo hliníková RAL 9006	7	9,00	<b>10,80</b>	9,00	<b>10,80</b>	8,10	<b>9,72</b>	8,10	<b>9,72</b>	7,90	<b>9,48</b>
		069689		069696		069702		069719		069726	
<b>PS</b> Prachovo šedá RAL 7037	8	9,00	<b>10,80</b>	9,00	<b>10,80</b>	8,10	<b>9,72</b>	8,10	<b>9,72</b>	7,90	<b>9,48</b>
		070883		070890		070906		070913		070920	
<b>MM</b> Metalická medená RAL extra	9	9,45	<b>11,34</b>			8,60	<b>10,32</b>	8,60	<b>10,32</b>	8,40	<b>10,08</b>
		070340				070364		070371		070388	
<b>BHT – P.20</b> Bielo hliníková tmavá RAL 9007	10									9,50	<b>11,40</b>
										096128	
<b>MZ</b> Machovo zelená RAL 6005	11	9,45	<b>11,34</b>							8,40	<b>10,08</b>
		070586								070593	
<b>MOT</b> Tmavo modrá RAL 5010	12	9,45	<b>11,34</b>							8,40	<b>10,08</b>
		070494								070500	
<b>TZ</b> Trávovo zelená RAL 6011	13	9,45	<b>11,34</b>					8,60	<b>10,32</b>		
		071521 *						071538			
<b>Balenie v m</b> 		<b>10</b>		<b>15</b>		<b>10</b>		<b>10</b>		<b>15</b>	
<b>Balenie v m</b> 		<b>490</b>		<b>735</b>		<b>100</b>		<b>250</b>		<b>375</b>	

\* Výroba na objednávku

**POZINK**  
 POLYESTER

## ZVODOVÁ RÚRA [s=0,55]

P-PZR

Menovitá veľkosť	80		80		80		100		100	
	4,0		5,0		6,0		1,0		2,0	
Dĺžka v m	4,0		5,0		6,0		1,0		2,0	
Cena v €/m	Bez DPH	S DPH	Bez DPH	S DPH	Bez DPH	S DPH	Bez DPH	S DPH	Bez DPH	S DPH
<b>TM</b> 1 Testa di Moro RAL 8028	7,80	9,36	7,80	9,36	7,80	9,36	8,20	9,84	8,20	9,84
	071354		071354		071378 *		071385		071392	
<b>AN</b> 2 Antracit RAL 7016	7,80	9,36	7,80	9,36	7,80	9,36	8,20	9,84	8,20	9,84
	069511		069511		069535 *		069542		069559	
<b>IC</b> 3 Intenzívna čierna RAL 9005	7,80	9,36	7,80	9,36	7,80	9,36	8,20	9,84	8,20	9,84
	069955		069955		069979 *		069986		069993	
<b>OC</b> 4 Oceľovo červená RAL 3009	7,80	9,36	7,80	9,36	7,80	9,36	8,20	9,84	8,20	9,84
	070715		070715		070739 *		070746		070753	
<b>MH</b> 5 Medeno hnedá RAL 8004	7,90	9,48	7,90	9,48	7,90	9,48	8,30	9,96	8,30	9,96
	070173		070173		070197 *		070203		070210	
<b>SB</b> 6 Šedo biela RAL 9002	7,90	9,48	7,90	9,48	7,90	9,48	8,30	9,96	8,30	9,96
	071132		071132		071156 *		071163		071170	
<b>BH</b> 7 Bielo hliníková RAL 9006	7,90	9,48	7,90	9,48	7,90	9,48	8,30	9,96	8,30	9,96
	069733		069733		069757 *		069764		069771	
<b>PS</b> 8 Prachovo šedá RAL 7037	7,90	9,48	7,90	9,48	7,90	9,48	8,30	9,96	8,30	9,96
	070937		070937		070951 *		070968		070975	
<b>MM</b> 9 Metalická medená RAL extra	8,40	10,08	8,40	10,08			9,30	11,16	9,30	11,16
	070395		070395				070401		070418	
<b>BHT – P.20</b> 10 Bielo hliníková tmavá RAL 9007										
<b>MZ</b> 11 Machovo zelená RAL 6005	8,40	10,08								
	070609									
<b>MOT</b> 12 Tmavo modrá RAL 5010										
<b>TZ</b> 13 Trávovo zelená RAL 6011										
<b>Balenie v m</b> 📦	20		5		6		10		10	
<b>Balenie v m</b> 🚚	500		625		750		70		160	

\* Výroba na objednávku



POZINK  
POLYESTER

**ZVODOVÁ RÚRA [s=0,55]**
**P-PZR**

Menovitá veľkosť	100		100		100		100		120	
	3,0		4,0		5,0		6,0		1,0	
Dĺžka v m	3,0		4,0		5,0		6,0		1,0	
	Bez DPH	S DPH	Bez DPH	S DPH	Bez DPH	S DPH	Bez DPH	S DPH	Bez DPH	S DPH
<b>TM</b> Testa di Moro RAL 8028	8,00	<b>9,60</b>	8,00	<b>9,60</b>	8,00	<b>9,60</b>	8,00	<b>9,60</b>	11,90	<b>14,28</b>
	071408		071415		071422		071439 *		071446	
<b>AN</b> Antracit RAL 7016	8,00	<b>9,60</b>	8,00	<b>9,60</b>	8,00	<b>9,60</b>	8,00	<b>9,60</b>	11,90	<b>14,28</b>
	069566		069573		069580		069597 *		069603	
<b>IC</b> Intenzívna čierna RAL 9005	8,00	<b>9,60</b>	8,00	<b>9,60</b>	8,00	<b>9,60</b>	8,00	<b>9,60</b>	11,90	<b>14,28</b>
	070005		070012		070029		070036 *		070043	
<b>OC</b> Oceľovo červená RAL 3009	8,00	<b>9,60</b>	8,00	<b>9,60</b>	8,00	<b>9,60</b>	8,00	<b>9,60</b>	11,90	<b>14,28</b>
	070760		070777		070784 *		070791 *		070807	
<b>MH</b> Medeno hnedá RAL 8004	8,10	<b>9,72</b>	8,10	<b>9,72</b>	8,10	<b>9,72</b>	8,10	<b>9,72</b>	12,00	<b>14,40</b>
	070227		070234		070241 *		070258 *		070265	
<b>SB</b> Šedo biela RAL 9002	8,10	<b>9,72</b>	8,10	<b>9,72</b>	8,10	<b>9,72</b>	8,10	<b>9,72</b>	12,00	<b>14,40</b>
	071187		071194		071200 *		071217 *		071224	
<b>BH</b> Bielo hliníková RAL 9006	8,10	<b>9,72</b>	8,10	<b>9,72</b>	8,10	<b>9,72</b>	8,10	<b>9,72</b>	12,00	<b>14,40</b>
	069788		069795		069801 *		069818 *		069825	
<b>PS</b> Prachovo šedá RAL 7037	8,10	<b>9,72</b>	8,10	<b>9,72</b>	8,10	<b>9,72</b>	8,10	<b>9,72</b>	12,00	<b>14,40</b>
	070982		070999		071002 *		071019 *		071026	
<b>MM</b> Metalická medená RAL extra	9,10	<b>10,92</b>	9,10	<b>10,92</b>					12,80	<b>15,36</b>
	070425		070432						070449	
<b>BHT – P.20</b> Bielo hliníková tmavá RAL 9007	9,60	<b>11,52</b>	9,60	<b>11,52</b>						
	096135		096142							
<b>MZ</b> Machovo zelená RAL 6005	9,10	<b>10,92</b>	9,10	<b>10,92</b>						
	070616		070623							
<b>MOT</b> Tmavo modrá RAL 5010	9,10	<b>10,92</b>	9,10	<b>10,92</b>						
	070524		070531							
<b>TZ</b> Trávovo zelená RAL 6011	9,10	<b>10,92</b>	9,10	<b>10,92</b>						
	071545		071552							
<b>Balenie v m</b> 	<b>15</b>		<b>20</b>		<b>5</b>		<b>6</b>		<b>8</b>	
<b>Balenie v m</b> 	<b>240</b>		<b>320</b>		<b>400</b>		<b>480</b>		<b>480</b>	

\* Výroba na objednávku



**ZVODOVÁ RÚRA [s=0,55]**
**P-PZR**



Menovitá veľkosť	120		120		120		120		120		
	2,0		3,0		4,0		5,0		6,0		
Dĺžka v m	2,0		3,0		4,0		5,0		6,0		
Cena v €/m	Bez DPH	S DPH	Bez DPH	S DPH	Bez DPH	S DPH	Bez DPH	S DPH	Bez DPH	S DPH	
<b>TM</b> Testa di Moro RAL 8028	1	11,90	14,28	11,70	14,04	11,70	14,04	11,70	14,04	11,70	14,04
		071453		071460		071477		071484 *		071491 *	
<b>AN</b> Antracit RAL 7016	2	11,90	14,28	11,70	14,04	11,70	14,04	11,70	14,04	11,70	14,04
		069610		069627		069634		069641 *		069658 *	
<b>IC</b> Intenzívna čierna RAL 9005	3	11,90	14,28	11,70	14,04	11,70	14,04	11,70	14,04	11,70	14,04
		070050		070067		070074		070081 *		070098 *	
<b>OC</b> Oceľovo červená RAL 3009	4	11,90	14,28	11,70	14,04	11,70	14,04	11,70	14,04	11,70	14,04
		070814		070821		070838		070845 *		070852 *	
<b>MH</b> Medeno hnedá RAL 8004	5	12,00	14,40	11,80	14,16	11,80	14,16	11,80	14,16	11,80	14,16
		070272		070289		070296		070302 *		070319 *	
<b>SB</b> Šedo biela RAL 9002	6	12,00	14,40	11,80	14,16	11,80	14,16	11,80	14,16	11,80	14,16
		071231		071248		071255		071262		071279 *	
<b>BH</b> Bielo hliníková RAL 9006	7	12,00	14,40	11,80	14,16	11,80	14,16	11,80	14,16	11,80	14,16
		069832		069849		069856		069863		069870 *	
<b>PS</b> Prachovo šedá RAL 7037	8	12,00	14,40	11,80	14,16	11,80	14,16				
		071033		071040		071057					
<b>MM</b> Metalická medená RAL extra	9	12,80	15,36	12,60	15,12	12,60	15,12				
		070456		070463		070470					
<b>BHT – P.20</b> Bielo hliníková tmavá RAL 9007	10			13,40	16,08						
				096159							
<b>MZ</b> Machovo zelená RAL 6005	11			12,60	15,12	12,60	15,12				
				070630		070647					
<b>MOT</b> Tmavo modrá RAL 5010	12			12,60	15,12	12,60	15,12				
				070548		070555					
<b>TZ</b> Trávovo zelená RAL 6011	13			12,60	15,12	12,60	15,12				
				071569		071576					
<b>Balenie v m</b>		<b>10</b>		<b>15</b>		<b>20</b>		<b>5</b>		<b>6</b>	
<b>Balenie v m</b>		<b>90</b>		<b>135</b>		<b>180</b>		<b>300</b>		<b>360</b>	

\* Výroba na objednávku







**ZVODOVÁ RÚRA [s=0,55]**
**P-PZR**

Menovitá veľkosť	150		150	
	3,0		4,0	
Dĺžka v m	3,0		4,0	
Cena v €/m	Bez DPH	S DPH	Bez DPH	S DPH
<b>TM</b> 1 Testa di Moro RAL 8028	22,90	<b>27,48</b>	22,90	<b>27,48</b>
	071507		071514	
<b>AN</b> 2 Antracit RAL 7016	22,90	<b>27,48</b>	22,90	<b>27,48</b>
	069665		069672	
<b>IC</b> 3 Intenzívna čierna RAL 9005			22,90	<b>27,48</b>
			070111	
<b>OC</b> 4 Oceľovo červená RAL 3009			22,90	<b>27,48</b>
			070876	
<b>MH</b> 5 Medeno hnedá RAL 8004	22,90	<b>27,48</b>		
	070326			
<b>SB</b> 6 Šedo biela RAL 9002	22,90	<b>27,48</b>	22,90	<b>27,48</b>
	071286		071293	
<b>BH</b> 7 Bielo hliníková RAL 9006	22,90	<b>27,48</b>	22,90	<b>27,48</b>
	069887		069894	
<b>PS</b> 8 Prachovo šedá RAL 7037	22,90	<b>27,48</b>	22,90	<b>27,48</b>
	071064		071071	
<b>MM</b> 9 Metalická medená RAL extra	24,20	<b>29,04</b>		
	070487			
<b>BHT – P.20</b> 10 Bielo hliníková tmavá RAL 9007	24,70	<b>29,64</b>		
	096166			
<b>MZ</b> 11 Machovo zelená RAL 6005	24,20	<b>29,04</b>		
	070654			
<b>MOT</b> 12 Tmavo modrá RAL 5010			24,20	<b>29,04</b>
			070579	
<b>TZ</b> 13 Trávovo zelená RAL 6011	24,20	<b>29,04</b>		
	071583 *			
<b>Balenie v m</b> 	<b>3</b>		<b>4</b>	
<b>Balenie v m</b> 	<b>84</b>		<b>112</b>	

\* Výroba na objednávku

## SPOJKA ZVODOVEJ RÚRY

P-PSRU

Menovitá veľkosť	80		100		120	
	Bez DPH	S DPH	Bez DPH	S DPH	Bez DPH	S DPH
<b>TM</b> 1 Testa di Moro RAL 8028	4,25	<b>5,10</b>	4,40	<b>5,28</b>	4,90	<b>5,88</b>
	017581		017598		017604	
<b>AN</b> 2 Antracit RAL 7016	4,25	<b>5,10</b>	4,40	<b>5,28</b>	4,90	<b>5,88</b>
	017284		017291		017307	
<b>IC</b> 3 Intenzívna čierna RAL 9005	4,25	<b>5,10</b>	4,40	<b>5,28</b>	4,90	<b>5,88</b>
	017345		017352		017369	
<b>OC</b> 4 Oceľovo červená RAL 3009	4,25	<b>5,10</b>	4,40	<b>5,28</b>	4,90	<b>5,88</b>
	017499		017505		017512	
<b>MH</b> 5 Medeno hnedá RAL 8004	4,25	<b>5,10</b>	4,40	<b>5,28</b>	4,90	<b>5,88</b>
	017376		017383		017390	
<b>SB</b> 6 Šedo biela RAL 9002	4,25	<b>5,10</b>	4,40	<b>5,28</b>	4,90	<b>5,88</b>
	017550		017567		017574	
<b>BH</b> 7 Bielo hliníková RAL 9006	4,25	<b>5,10</b>	4,40	<b>5,28</b>	4,90	<b>5,88</b>
	017314		017321		017338	
<b>PS</b> 8 Prachovo šedá RAL 7037	4,25	<b>5,10</b>	4,40	<b>5,28</b>	4,90	<b>5,88</b>
	017529		017536		017543	
<b>MM</b> 9 Metalická medená RAL extra	4,25	<b>5,10</b>	4,40	<b>5,28</b>	4,90	<b>5,88</b>
	017406		017413		017420	
<b>BHT – P.20</b> 10 Bielo hliníková tmavá RAL 9007	4,25	<b>5,10</b>	4,40	<b>5,28</b>	4,90	<b>5,88</b>
	095657 *		095664		095671 *	
<b>MZ</b> 11 Machovo zelená RAL 6005	4,25	<b>5,10</b>	4,40	<b>5,28</b>	4,90	<b>5,88</b>
	017468 *		017475		017482	
<b>MOT</b> 12 Tmavo modrá RAL 5010	4,25	<b>5,10</b>	4,40	<b>5,28</b>	4,90	<b>5,88</b>
	017437 *		017444		017451	
<b>TZ</b> 13 Trávovo zelená RAL 6011	4,25	<b>5,10</b>	4,40	<b>5,28</b>	4,90	<b>5,88</b>
	017611 *		017628		017635 *	
<b>Balenie v ks</b> 	<b>10</b>		<b>10</b>		<b>8</b>	
<b>Balenie v ks</b> 	<b>900</b>		<b>900</b>		<b>720</b>	

\* Výroba na objednávku



## ZVODOVÉ KOLENO ODSKOKOVÉ

P-PKO



Menovitá veľkosť	80		100		120	
	Bez DPH	S DPH	Bez DPH	S DPH	Bez DPH	S DPH
<b>TM</b> 1 Testa di Moro RAL 8028	9,40	<b>11,28</b>	9,70	<b>11,64</b>	13,95	<b>16,74</b>
	034045		034052		034069	
<b>AN</b> 2 Antracit RAL 7016	9,40	<b>11,28</b>	9,70	<b>11,64</b>	13,95	<b>16,74</b>
	033741		033758		033765	
<b>IC</b> 3 Intenzívna čierna RAL 9005	9,40	<b>11,28</b>	9,70	<b>11,64</b>	13,95	<b>16,74</b>
	033802		033819		033826	
<b>OC</b> 4 Oceľovo červená RAL 3009	9,40	<b>11,28</b>	9,70	<b>11,64</b>	13,95	<b>16,74</b>
	033956		033963		033970	
<b>MH</b> 5 Medeno hnedá RAL 8004	9,40	<b>11,28</b>	9,70	<b>11,64</b>	13,95	<b>16,74</b>
	033833		033840		033857	
<b>SB</b> 6 Šedo biela RAL 9002	9,40	<b>11,28</b>	9,70	<b>11,64</b>	13,95	<b>16,74</b>
	034014		034021		034038	
<b>BH</b> 7 Bielo hliníková RAL 9006	9,40	<b>11,28</b>	9,70	<b>11,64</b>	13,95	<b>16,74</b>
	033772		033789		033796	
<b>PS</b> 8 Prachovo šedá RAL 7037	9,40	<b>11,28</b>	9,70	<b>11,64</b>	13,95	<b>16,74</b>
	033987		033994		034007	
<b>MM</b> 9 Metalická medená RAL extra	9,40	<b>11,28</b>	9,70	<b>11,64</b>	13,95	<b>16,74</b>
	033864		033871		033888	
<b>BHT – P.20</b> 10 Bielo hliníková tmavá RAL 9007	9,40	<b>11,28</b>	9,70	<b>11,64</b>	13,95	<b>16,74</b>
	095688		095695		095701	
<b>MZ</b> 11 Machovo zelená RAL 6005	9,40	<b>11,28</b>	9,70	<b>11,64</b>	13,95	<b>16,74</b>
	033925		033932		033949	
<b>MOT</b> 12 Tmavo modrá RAL 5010	9,40	<b>11,28</b>	9,70	<b>11,64</b>	13,95	<b>16,74</b>
	033895		033901		033918	
<b>TZ</b> 13 Trávovo zelená RAL 6011	9,40	<b>11,28</b>	9,70	<b>11,64</b>	13,95	<b>16,74</b>
	034076		034083		034090	
<b>Balenie v ks</b>	<b>20</b>		<b>20</b>		<b>15</b>	
<b>Balenie v ks</b>	<b>320</b>		<b>240</b>		<b>180</b>	

## ZVODOVÁ ODBOČKA 72°

P-PZO

Menovitá veľkosť	80/80		100/60		100/80		100/100	
	Bez DPH	S DPH	Bez DPH	S DPH	Bez DPH	S DPH	Bez DPH	S DPH
<b>TM</b> 1 Testa di Moro RAL 8028	15,65	<b>18,78</b>	17,40	<b>20,88</b>	17,40	<b>20,88</b>	18,00	<b>21,60</b>
	016157		016164		016171		016188	
<b>AN</b> 2 Antracit RAL 7016	15,65	<b>18,78</b>	17,40	<b>20,88</b>	17,40	<b>20,88</b>	18,00	<b>21,60</b>
	015259		015266		015273		015280	
<b>IC</b> 3 Intenzívna čierna RAL 9005	15,65	<b>18,78</b>	17,40	<b>20,88</b>	17,40	<b>20,88</b>	18,00	<b>21,60</b>
	015433		015440		015457		015464	
<b>OC</b> 4 Oceľovo červená RAL 3009	15,65	<b>18,78</b>	17,40	<b>20,88</b>	17,40	<b>20,88</b>	18,00	<b>21,60</b>
	015884		015891		015907		015914	
<b>MH</b> 5 Medeno hnedá RAL 8004	15,65	<b>18,78</b>	17,40	<b>20,88</b>	17,40	<b>20,88</b>	18,00	<b>21,60</b>
	015525		015532 *		015549		015556	
<b>SB</b> 6 Šedo biela RAL 9002	15,65	<b>18,78</b>	17,40	<b>20,88</b>	17,40	<b>20,88</b>	18,00	<b>21,60</b>
	016065		016072 *		016089		016096	
<b>BH</b> 7 Bielo hliníková RAL 9006	15,65	<b>18,78</b>	17,40	<b>20,88</b>	17,40	<b>20,88</b>	18,00	<b>21,60</b>
	015341		015358 *		015365		015372	
<b>PS</b> 8 Prachovo šedá RAL 7037	15,65	<b>18,78</b>	17,40	<b>20,88</b>	17,40	<b>20,88</b>	18,00	<b>21,60</b>
	015976 *		015983 *		015990		016003	
<b>MM</b> 9 Metalická medená RAL extra	15,65	<b>18,78</b>	17,40	<b>20,88</b>	17,40	<b>20,88</b>	18,00	<b>21,60</b>
	015617		015624 *		015631		015648	
<b>BHT – P.20</b> 10 Bielo hliníková tmavá RAL 9007	15,65	<b>18,78</b>			17,40	<b>20,88</b>	18,00	<b>21,60</b>
	096005 *				096012 *		096029 *	
<b>MZ</b> 11 Machovo zelená RAL 6005	15,65	<b>18,78</b>	17,40	<b>20,88</b>	17,40	<b>20,88</b>	18,00	<b>21,60</b>
	015792		015808 *		015815		015822	
<b>MOT</b> 12 Tmavo modrá RAL 5010	15,65	<b>18,78</b>	17,40	<b>20,88</b>	17,40	<b>20,88</b>	18,00	<b>21,60</b>
	015709 *		015716 *		015723 *		015730	
<b>TZ</b> 13 Trávovo zelená RAL 6011	15,65	<b>18,78</b>	17,40	<b>20,88</b>	17,40	<b>20,88</b>	18,00	<b>21,60</b>
	016249 *		016256 *		016263 *		016270 *	
<b>Balenie v ks</b> 	<b>4</b>		<b>3</b>		<b>4</b>		<b>4</b>	
<b>Balenie v ks</b> 	<b>120</b>		<b>90</b>		<b>120</b>		<b>120</b>	

\* Výroba na objednávku



## ZVODOVÁ ODBOČKA 72°

P-PZO



Menovitá veľkosť	120/80		120/100		120/120		150/120		150/150	
	Bez DPH	S DPH	Bez DPH	S DPH	Bez DPH	S DPH	Bez DPH	S DPH	Bez DPH	S DPH
<b>TM</b> 1 Testa di Moro RAL 8028	19,80	<b>23,76</b>	19,80	<b>23,76</b>	19,80	<b>23,76</b>	28,80	<b>34,56</b>	28,80	<b>34,56</b>
	016195		016201		016218		016225 *		016232 *	
<b>AN</b> 2 Antracit RAL 7016	19,80	<b>23,76</b>	19,80	<b>23,76</b>	19,80	<b>23,76</b>	28,80	<b>34,56</b>	28,80	<b>34,56</b>
	015297		015303		015310		015327 *		015334 *	
<b>IC</b> 3 Intenzívna čierna RAL 9005	19,80	<b>23,76</b>	19,80	<b>23,76</b>	19,80	<b>23,76</b>	28,80	<b>34,56</b>	28,80	<b>34,56</b>
	015471		015488		015495		015501 *		015518 *	
<b>OC</b> 4 Oceľovo červená RAL 3009	19,80	<b>23,76</b>	19,80	<b>23,76</b>	19,80	<b>23,76</b>	28,80	<b>34,56</b>	28,80	<b>34,56</b>
	015921		015938		015945		015952 *		015969 *	
<b>MH</b> 5 Medeno hnedá RAL 8004	19,80	<b>23,76</b>	19,80	<b>23,76</b>	19,80	<b>23,76</b>	28,80	<b>34,56</b>	28,80	<b>34,56</b>
	015563		015570		015587		015594 *		015600 *	
<b>SB</b> 6 Šedo biela RAL 9002	19,80	<b>23,76</b>	19,80	<b>23,76</b>	19,80	<b>23,76</b>	28,80	<b>34,56</b>	28,80	<b>34,56</b>
	016102		016119		016126		016133 *		016140 *	
<b>BH</b> 7 Bielo hliníková RAL 9006	19,80	<b>23,76</b>	19,80	<b>23,76</b>	19,80	<b>23,76</b>	28,80	<b>34,56</b>	28,80	<b>34,56</b>
	015389		015396		015402		015419 *		015426 *	
<b>PS</b> 8 Prachovo šedá RAL 7037	19,80	<b>23,76</b>	19,80	<b>23,76</b>	19,80	<b>23,76</b>	28,80	<b>34,56</b>	28,80	<b>34,56</b>
	016010 *		016027		016034		016041 *		016058 *	
<b>MM</b> 9 Metalická medená RAL extra	19,80	<b>23,76</b>	19,80	<b>23,76</b>	19,80	<b>23,76</b>	28,80	<b>34,56</b>	28,80	<b>34,56</b>
	015655 *		015662		015679		015686 *		015693 *	
<b>BHT – P.20</b> 10 Bielo hliníková tmavá RAL 9007	19,80	<b>23,76</b>	19,80	<b>23,76</b>	19,80	<b>23,76</b>				
	096036 *		096043 *		096050 *					
<b>MZ</b> 11 Machovo zelená RAL 6005	19,80	<b>23,76</b>	19,80	<b>23,76</b>	19,80	<b>23,76</b>	28,80	<b>34,56</b>	28,80	<b>34,56</b>
	015839 *		015846 *		015853 *		015860 *		015877 *	
<b>MOT</b> 12 Tmavo modrá RAL 5010	19,80	<b>23,76</b>	19,80	<b>23,76</b>	19,80	<b>23,76</b>	28,80	<b>34,56</b>	28,80	<b>34,56</b>
	015747 *		015754 *		015761 *		015778 *		015785 *	
<b>TZ</b> 13 Trávovo zelená RAL 6011	19,80	<b>23,76</b>	19,80	<b>23,76</b>	19,80	<b>23,76</b>	28,80	<b>34,56</b>	28,80	<b>34,56</b>
	016287 *		016294 *		016300 *		016317 *		016324 *	
<b>Balenie v ks</b> 	<b>3</b>		<b>3</b>		<b>3</b>		<b>2</b>		<b>2</b>	
<b>Balenie v ks</b> 	<b>90</b>		<b>90</b>		<b>90</b>		<b>36</b>		<b>36</b>	

\* Výroba na objednávku

## ZVODOVÝ ROZDELOVAČ VODY

P-PRV



Menovitá veľkosť	80		100		120	
	Bez DPH	S DPH	Bez DPH	S DPH	Bez DPH	S DPH
<b>TM</b> 1 Testa di Moro RAL 8028	195,00	<b>234,00</b>	199,90	<b>239,88</b>	259,00	<b>310,80</b>
	088413 *		088420		088437 *	
<b>AN</b> 2 Antracit RAL 7016	195,00	<b>234,00</b>	199,90	<b>239,88</b>	259,00	<b>310,80</b>
	088116 *		088123		088130 *	
<b>IC</b> 3 Intenzívna čierna RAL 9005	195,00	<b>234,00</b>	199,90	<b>239,88</b>	259,00	<b>310,80</b>
	088178 *		088185 *		088192 *	
<b>OC</b> 4 Oceľovo červená RAL 3009	195,00	<b>234,00</b>	199,90	<b>239,88</b>	259,00	<b>310,80</b>
	088321 *		088338 *		088345 *	
<b>MH</b> 5 Medeno hnedá RAL 8004	195,00	<b>234,00</b>	199,90	<b>239,88</b>	259,00	<b>310,80</b>
	088208 *		088215 *		088222 *	
<b>SB</b> 6 Šedo biela RAL 9002	195,00	<b>234,00</b>	199,90	<b>239,88</b>	259,00	<b>310,80</b>
	088383 *		088390 *		088406 *	
<b>BH</b> 7 Bielo hliníková RAL 9006	195,00	<b>234,00</b>	199,90	<b>239,88</b>	259,00	<b>310,80</b>
	088147 *		088154 *		088161 *	
<b>PS</b> 8 Prachovo šedá RAL 7037	195,00	<b>234,00</b>	199,90	<b>239,88</b>	259,00	<b>310,80</b>
	088352 *		088369 *		088376 *	
<b>MM</b> 9 Metalická medená RAL extra	195,00	<b>234,00</b>	199,90	<b>239,88</b>	259,00	<b>310,80</b>
	088239 *		088246 *		088253 *	
<b>BHT – P.20</b> 10 Bielo hliníková tmavá RAL 9007	195,00	<b>234,00</b>	199,90	<b>239,88</b>	259,00	<b>310,80</b>
	095756 *		095763 *		095770 *	
<b>MZ</b> 11 Machovo zelená RAL 6005	195,00	<b>234,00</b>	199,90	<b>239,88</b>	259,00	<b>310,80</b>
	088291 *		088307 *		088314 *	
<b>MOT</b> 12 Tmavo modrá RAL 5010	195,00	<b>234,00</b>	199,90	<b>239,88</b>	259,00	<b>310,80</b>
	088260 *		088277 *		088284 *	
<b>TZ</b> 13 Trávovo zelená RAL 6011	195,00	<b>234,00</b>	199,90	<b>239,88</b>	259,00	<b>310,80</b>
	088444 *		088451 *		088468 *	
<b>Balenie v ks</b>	<b>1</b>		<b>1</b>		<b>1</b>	
<b>Balenie v ks</b>	-		-		-	

\* Výroba na objednávku

## ZVODOVÁ OBJÍMKA S HROTOM 150 mm

P-PO

Menovitá veľkosť	80		100		120	
	Bez DPH	S DPH	Bez DPH	S DPH	Bez DPH	S DPH
<b>TM</b> 1 Testa di Moro RAL 8028	3,30	<b>3,96</b>	3,35	<b>4,02</b>	4,00	<b>4,80</b>
	002136		002143		002150	
<b>AN</b> 2 Antracit RAL 7016	3,30	<b>3,96</b>	3,35	<b>4,02</b>	4,00	<b>4,80</b>
	001986		001993		002006	
<b>IC</b> 3 Intenzívna čierna RAL 9005	3,30	<b>3,96</b>	3,35	<b>4,02</b>	4,00	<b>4,80</b>
	002013		002020		002037	
<b>OC</b> 4 Oceľovo červená RAL 3009	3,30	<b>3,96</b>	3,35	<b>4,02</b>	4,00	<b>4,80</b>
	002075		002082		002099	
<b>MH</b> 5 Medeno hnedá RAL 8004	3,30	<b>3,96</b>	3,35	<b>4,02</b>	4,00	<b>4,80</b>
	002044		002051		002068	
<b>SB</b> 6 Šedo biela RAL 9002	3,30	<b>3,96</b>	3,35	<b>4,02</b>	4,00	<b>4,80</b>
	002105		002112		002129	
<b>Balenie v ks</b> 📦	<b>25</b>		<b>25</b>		<b>25</b>	
<b>Balenie v ks</b> 🚚	<b>1 000</b>		<b>1 000</b>		<b>1 000</b>	



## ZVODOVÁ OBJÍMKA S HROTOM 200 mm



P-POD

Menovitá veľkosť	80		100		120	
	Bez DPH	S DPH	Bez DPH	S DPH	Bez DPH	S DPH
<b>TM</b> 1 Testa di Moro RAL 8028	3,50	<b>4,20</b>	3,50	<b>4,20</b>	4,05	<b>4,86</b>
	001955		001962		001979	
<b>AN</b> 2 Antracit RAL 7016	3,50	<b>4,20</b>	3,50	<b>4,20</b>	4,05	<b>4,86</b>
	001801		001818		001825	
<b>IC</b> 3 Intenzívna čierna RAL 9005	3,50	<b>4,20</b>	3,50	<b>4,20</b>	4,05	<b>4,86</b>
	001832		001849		001856	
<b>OC</b> 4 Oceľovo červená RAL 3009	3,50	<b>4,20</b>	3,50	<b>4,20</b>	4,05	<b>4,86</b>
	001894		001900		001917	
<b>MH</b> 5 Medeno hnedá RAL 8004	3,50	<b>4,20</b>	3,50	<b>4,20</b>	4,05	<b>4,86</b>
	001863		001870		001887	
<b>SB</b> 6 Šedo biela RAL 9002	3,50	<b>4,20</b>	3,50	<b>4,20</b>	4,05	<b>4,86</b>
	001924		001931		001948	
<b>Balenie v ks</b> 📦	<b>25</b>		<b>25</b>		<b>25</b>	
<b>Balenie v ks</b> 🚚	<b>1 000</b>		<b>1 000</b>		<b>1 000</b>	



## ZVODOVÁ OBJÍMKA S HROTOM 300 mm

P-PODD

Menovitá veľkosť	100		120	
	Bez DPH	S DPH	Bez DPH	S DPH
<b>TM</b> 1 Testa di Moro RAL 8028	4,55	<b>5,46</b>	4,95	<b>5,94</b>
	002402		002419	
<b>AN</b> 2 Antracit RAL 7016	4,55	<b>5,46</b>	4,95	<b>5,94</b>
	002303		002310	
<b>IC</b> 3 Intenzívna čierna RAL 9005	4,55	<b>5,46</b>	4,95	<b>5,94</b>
	002327		002334	
<b>OC</b> 4 Oceľovo červená RAL 3009	4,55	<b>5,46</b>	4,95	<b>5,94</b>
	002365		002372	
<b>MH</b> 5 Medeno hnedá RAL 8004	4,55	<b>5,46</b>	4,95	<b>5,94</b>
	002341		002358	
<b>SB</b> 6 Šedo biela RAL 9002	4,55	<b>5,46</b>	4,95	<b>5,94</b>
	002389		002396	
<b>Balenie v ks</b> 	<b>20</b>		<b>20</b>	
<b>Balenie v ks</b> 	<b>800</b>		<b>800</b>	





## ZVODOVÁ OBJÍMKA M10

P-POB

Menovitá veľkosť	60		80		100		120		150	
	Bez DPH	S DPH	Bez DPH	S DPH	Bez DPH	S DPH	Bez DPH	S DPH	Bez DPH	S DPH
<b>TM</b> 1 Testa di Moro RAL 8028	2,90	<b>3,48</b>	2,65	<b>3,18</b>	2,75	<b>3,30</b>	3,30	<b>3,96</b>	4,90	<b>5,88</b>
	074119		074126		074133		074140		074157	
<b>AN</b> 2 Antracit RAL 7016	2,90	<b>3,48</b>	2,65	<b>3,18</b>	2,75	<b>3,30</b>	3,30	<b>3,96</b>	4,90	<b>5,88</b>
	073471		073488		073495		073501		073518	
<b>IC</b> 3 Intenzívna čierna RAL 9005	2,90	<b>3,48</b>	2,65	<b>3,18</b>	2,75	<b>3,30</b>	3,30	<b>3,96</b>	4,90	<b>5,88</b>
	073679		073686		073693		073709		073716	
<b>OC</b> 4 Oceľovo červená RAL 3009	2,90	<b>3,48</b>	2,65	<b>3,18</b>	2,75	<b>3,30</b>	3,30	<b>3,96</b>	4,90	<b>5,88</b>
	073914		073921		073938		073945		073952	
<b>MH</b> 5 Medeno hnedá RAL 8004	2,90	<b>3,48</b>	2,65	<b>3,18</b>	2,75	<b>3,30</b>	3,30	<b>3,96</b>	4,90	<b>5,88</b>
	073723		073730		073747		073754		073761	
<b>SB</b> 6 Šedo biela RAL 9002	2,90	<b>3,48</b>	2,65	<b>3,18</b>	2,75	<b>3,30</b>	3,30	<b>3,96</b>	4,90	<b>5,88</b>
	074010		074027		074034		074041		074058	
<b>BH</b> 7 Bielo hliníková RAL 9006	2,90	<b>3,48</b>	2,65	<b>3,18</b>	2,75	<b>3,30</b>	3,30	<b>3,96</b>	4,90	<b>5,88</b>
	073570		073587		073594		073600		073617	
<b>PS</b> 8 Prachovo šedá RAL 7037	2,90	<b>3,48</b>	2,65	<b>3,18</b>	2,75	<b>3,30</b>	3,30	<b>3,96</b>	4,90	<b>5,88</b>
	073969		073976		073983		073990		074003	
<b>MM</b> 9 Metalická medená RAL extra	2,90	<b>3,48</b>	2,65	<b>3,18</b>	2,75	<b>3,30</b>	3,30	<b>3,96</b>	4,90	<b>5,88</b>
	073778		073785		073792		073808		077158	
<b>BHT – P.20</b> 10 Bielo hliníková tmavá RAL 9007	2,90	<b>3,48</b>	2,65	<b>3,18</b>	2,75	<b>3,30</b>	3,30	<b>3,96</b>	4,90	<b>5,88</b>
	119711		094537		094544		094551		094674	
<b>MZ</b> 11 Machovo zelená RAL 6005	2,90	<b>3,48</b>	2,65	<b>3,18</b>	2,75	<b>3,30</b>	3,30	<b>3,96</b>	4,90	<b>5,88</b>
	073860		073877		073884		073891		073907	
<b>MOT</b> 12 Tmavo modrá RAL 5010	2,90	<b>3,48</b>	2,65	<b>3,18</b>	2,75	<b>3,30</b>	3,30	<b>3,96</b>	4,90	<b>5,88</b>
	073815		073822		073839		073846		073853	
<b>TZ</b> 13 Trávovo zelená RAL 6011	2,90	<b>3,48</b>	2,65	<b>3,18</b>	2,75	<b>3,30</b>	3,30	<b>3,96</b>	4,90	<b>5,88</b>
	074164 *		074171		074188		074195		074201 *	
<b>Balenie v ks</b> 📦	<b>25</b>		<b>25</b>		<b>25</b>		<b>25</b>		<b>20</b>	
<b>Balenie v ks</b> 🚚	<b>3 000</b>		<b>3 000</b>		<b>3 000</b>		<b>3 000</b>		<b>2 400</b>	

\* Výroba na objednávku



## ZVODOVÁ OBJÍMKA M8

P-POB





Menovitá veľkosť	60		80		100		120		150	
	Bez DPH	S DPH	Bez DPH	S DPH	Bez DPH	S DPH	Bez DPH	S DPH	Bez DPH	S DPH
<b>TM</b> 1 Testa di Moro RAL 8028	2,90	<b>3,48</b>	2,65	<b>3,18</b>	2,75	<b>3,30</b>	3,30	<b>3,96</b>	4,90	<b>5,88</b>
	074065		074072		074089		074096		074102	
<b>AN</b> 2 Antracit RAL 7016	2,90	<b>3,48</b>	2,65	<b>3,18</b>	2,75	<b>3,30</b>	3,30	<b>3,96</b>	4,90	<b>5,88</b>
	073426		073433		073440		073457		073464	
<b>IC</b> 3 Intenzívna čierna RAL 9005	2,90	<b>3,48</b>	2,65	<b>3,18</b>	2,75	<b>3,30</b>	3,30	<b>3,96</b>	4,90	<b>5,88</b>
	073624		073631		073648		073655		073662	
<b>BH</b> 7 Bielo hliníková RAL 9006	2,90	<b>3,48</b>	2,65	<b>3,18</b>	2,75	<b>3,30</b>	3,30	<b>3,96</b>	4,90	<b>5,88</b>
	073532		073525		073549		073556		073563	
<b>Balenie v ks</b>	<b>25</b>		<b>25</b>		<b>25</b>		<b>25</b>		<b>20</b>	
<b>Balenie v ks</b>	<b>3 000</b>		<b>3 000</b>		<b>3 000</b>		<b>3 000</b>		<b>2 400</b>	



## NEREZOVÁ SKRUTKA S PVC PODLOŽKOU M6x20

P-POB-NSK





Menovitá veľkosť	EAN číslo výrobku	Balenie v ks		Cena [€/ks]	
				Bez DPH	S DPH
M6 x 20 *	071675	1	–	0,18	<b>0,22</b>

\* Výroba na objednávku

## ZÁVITOVÝ HROT TORX M10

P-POB-HT





Menovitá veľkosť	EAN číslo výrobku	Balenie v ks		Cena [€/ks]	
				Bez DPH	S DPH
80	002464	100	40 000	0,77	<b>0,92</b>
140	002471	100	28 000	1,03	<b>1,24</b>
200	002488	100	20 000	1,31	<b>1,57</b>
250	002495	100	17 000	1,47	<b>1,76</b>
300	002501	100	11 200	1,52	<b>1,82</b>

POZINK  
POLYESTER

## HMOŽDINKA MODRÁ BEZ LAMELY M10

P-POB-HN DB





Menovitá veľkosť	EAN číslo výrobku	Balenie v ks		Cena [€/ks]	
				Bez DPH	S DPH
120	002426	100	25 000	0,37	<b>0,44</b>

## HMOŽDINKA MODRÁ S LAMELOU M10

P-POB-HN DB





Menovitá veľkosť	EAN číslo výrobku	Balenie v ks		Cena [€/ks]	
				Bez DPH	S DPH
180	002433	100	12 000	0,38	<b>0,46</b>
240	002440	100	12 000	0,45	<b>0,54</b>
280	002457	100	12 000	0,48	<b>0,58</b>

## KOMBISKRUTKA TORX M10

P-POB-ZT/SZ



Menovitá veľkosť	EAN číslo výrobku	Balenie v ks		Cena [€/ks]	
				Bez DPH	S DPH
140	002587	50	10 400	0,44	<b>0,53</b>
180	002594	50	10 400	0,56	<b>0,67</b>

## HMOŽDINKA ŠTVORHRANÝ HROT 7x7

P-POB-HN R1



Menovitá veľkosť	EAN číslo výrobku	Balenie v ks		Cena [€/ks]	
				Bez DPH	S DPH
200/60	003263	250	15 000	0,17	<b>0,20</b>

## NYLON IZOLAČNÁ HMOŽDINKA S OCHRANNOU KRYTKOU M10

P-POB-HN IZOL



Menovitá veľkosť	EAN číslo výrobku	Balenie v ks		Cena [€/ks]	
				Bez DPH	S DPH
M10 x 96	001207	25	5 000	4,88	<b>5,86</b>

## ZÁVITOVÁ TYČ M10

P-POB-ZT



Menovitá veľkosť	EAN číslo výrobku	Balenie v ks		Cena [€/ks]	
				Bez DPH	S DPH
60	002556	100	20 800	0,20	<b>0,24</b>
100	002563	100	15 600	0,32	<b>0,38</b>
150	002570	50	10 400	0,55	<b>0,66</b>

## MONTÁŽNA PLATŇA M10

P-POB-ZT MP





Menovitá veľkosť	EAN číslo výrobku	Balenie v ks		Cena [€/ks]	
				Bez DPH	S DPH
80 x 30	002518	25	5 200	1,16	<b>1,39</b>

## ZÁVITOVÝ HROT M8

## P-POB-HB





Menovitá vel'kost'	EAN číslo výrobku	Balenie v ks		Cena [€/ks]	
				Bez DPH	S DPH
150	071590	100	5 000	0,65	<b>0,78</b>
200	071606	100	5 000	0,92	<b>1,10</b>
250	071613	100	5 000	1,05	<b>1,26</b>
300	071620	100	8 000	1,10	<b>1,32</b>

## HMOŽDINKA ŠEDÁ HROTU OBJÍMKY M8

## P-POB-HBN-SS

















Menovitá vel'kost'	EAN číslo výrobku	Balenie v ks		Cena [€/ks]	
				Bez DPH	S DPH
150	071637	100	5 000	0,25	<b>0,30</b>
200	071644	100	5 000	0,26	<b>0,31</b>
250	071651	100	5 000	0,35	<b>0,42</b>
300	071668	100	8 000	0,37	<b>0,44</b>

## GUMOVÁ FAREBNÁ KRYTKA HROTU OBJÍMKY

## P-POB-HT AKG



Menovitá vel'kost'	EAN číslo výrobku	Balenie v ks		Cena [€/ks]	
				Bez DPH	S DPH
 <b>29 x 13</b>	002280	50	20 000	0,24	<b>0,29</b>
 <b>29 x 13</b>	002211	50	20 000	0,24	<b>0,29</b>
 <b>29 x 13</b>	002235	50	20 000	0,24	<b>0,29</b>
 <b>29 x 13</b>	002266	50	20 000	0,24	<b>0,29</b>
 <b>29 x 13</b>	002242	50	20 000	0,24	<b>0,29</b>
  <b>29 x 13</b>	002228	50	20 000	0,24	<b>0,29</b>
   <b>29 x 13</b>	002273	50	20 000	0,24	<b>0,29</b>
 <b>29 x 13</b>	002259	50	20 000	0,24	<b>0,29</b>
 <b>29 x 13</b>	002297	50	20 000	0,24	<b>0,29</b>

## ZACHYTÁVAČ VODY

P-PZV



Menovitá veľkosť	80		100		120	
	Bez DPH	S DPH	Bez DPH	S DPH	Bez DPH	S DPH
<b>TM</b> 1 Testa di Moro RAL 8028	12,55	<b>15,06</b>	12,95	<b>15,54</b>	19,00	<b>22,80</b>
	034533		034540		034557	
<b>AN</b> 2 Antracit RAL 7016	12,55	<b>15,06</b>	12,95	<b>15,54</b>	19,00	<b>22,80</b>
	034410		034427		034434	
<b>IC</b> 3 Intenzívna čierna RAL 9005	12,55	<b>15,06</b>	12,95	<b>15,54</b>	19,00	<b>22,80</b>
	034441		034458		034465	
<b>OC</b> 4 Oceľovo červená RAL 3009	12,55	<b>15,06</b>	12,95	<b>15,54</b>	19,00	<b>22,80</b>
	034502		034519		034526	
<b>MH</b> 5 Medeno hnedá RAL 8004	12,55	<b>15,06</b>	12,95	<b>15,54</b>	19,00	<b>22,80</b>
	034472		034489		034496	
<b>Balenie v ks</b>	<b>6</b>		<b>5</b>		<b>3</b>	
<b>Balenie v ks</b>	<b>180</b>		<b>150</b>		<b>90</b>	

### ZACHYTÁVAČ VODY+SITKO

P-PZVS



Menovitá veľkosť	80		100		120	
	Bez DPH	S DPH	Bez DPH	S DPH	Bez DPH	S DPH
<b>TM</b> 1 Testa di Moro RAL 8028	12,55	<b>15,06</b>	12,95	<b>15,54</b>	19,00	<b>22,80</b>
	034861		034878		034885	
<b>AN</b> 2 Antracit RAL 7016	12,55	<b>15,06</b>	12,95	<b>15,54</b>	19,00	<b>22,80</b>
	034564		034571		034588	
<b>IC</b> 3 Intenzívna čierna RAL 9005	12,55	<b>15,06</b>	12,95	<b>15,54</b>	19,00	<b>22,80</b>
	034625		034632		034649	
<b>OC</b> 4 Oceľovo červená RAL 3009	12,55	<b>15,06</b>	12,95	<b>15,54</b>	19,00	<b>22,80</b>
	034779		034786		034793	
<b>MH</b> 5 Medeno hnedá RAL 8004	12,55	<b>15,06</b>	12,95	<b>15,54</b>	19,00	<b>22,80</b>
	034656		034663		034670	
<b>SB</b> 6 Šedo biela RAL 9002	12,55	<b>15,06</b>	12,95	<b>15,54</b>	19,00	<b>22,80</b>
	034830		034847		034854	
<b>BH</b> 7 Bielo hliníková RAL 9006	12,55	<b>15,06</b>	12,95	<b>15,54</b>	19,00	<b>22,80</b>
	034595		034601		034618	
<b>PS</b> 8 Prachovo šedá RAL 7037	12,55	<b>15,06</b>	12,95	<b>15,54</b>	19,00	<b>22,80</b>
	034809		034816		034823	
<b>MM</b> 9 Metalická medená RAL extra	12,55	<b>15,06</b>	12,95	<b>15,54</b>	19,00	<b>22,80</b>
	034687		034694		034700	
<b>BHT – P.20</b> 10 Bielo hliníková tmavá RAL 9007	12,55	<b>15,06</b>	12,95	<b>15,54</b>	19,00	<b>22,80</b>
	095718		095725		095732	
<b>MZ</b> 11 Machovo zelená RAL 6005	12,55	<b>15,06</b>	12,95	<b>15,54</b>	19,00	<b>22,80</b>
	034748		034755		034762	
<b>MOT</b> 12 Tmavo modrá RAL 5010	12,55	<b>15,06</b>	12,95	<b>15,54</b>	19,00	<b>22,80</b>
	034717		034724		034731	
<b>TZ</b> 13 Trávovo zelená RAL 6011	12,55	<b>15,06</b>	12,95	<b>15,54</b>	19,00	<b>22,80</b>
	034892 *		034908		034915	
<b>Balenie v ks</b> 📦	<b>6</b>		<b>5</b>		<b>3</b>	
<b>Balenie v ks</b> 🚚	<b>180</b>		<b>150</b>		<b>90</b>	

\* Výroba na objednávku

## HLINÍKOVÝ ZACHYTÁVAČ VODY+HADICA

P-PZVHA

Menovitá veľkosť	80		100		120	
	Bez DPH	S DPH	Bez DPH	S DPH	Bez DPH	S DPH
<b>TM</b> 1 Testa di Moro RAL 8028	65,00	<b>78,00</b>	65,00	<b>78,00</b>	133,50	<b>160,20</b>
	018793		018809		018816	
<b>AN</b> 2 Antracit RAL 7016	65,00	<b>78,00</b>	65,00	<b>78,00</b>	133,50	<b>160,20</b>
	018496		018502		018519	
<b>IC</b> 3 Intenzívna čierna RAL 9005	65,00	<b>78,00</b>	65,00	<b>78,00</b>	133,50	<b>160,20</b>
	018557		018564		018571	
<b>OC</b> 4 Oceľovo červená RAL 3009	65,00	<b>78,00</b>	65,00	<b>78,00</b>	133,50	<b>160,20</b>
	018700		018717		018724 *	
<b>MH</b> 5 Medeno hnedá RAL 8004	65,00	<b>78,00</b>	65,00	<b>78,00</b>	133,50	<b>160,20</b>
	018588 *		018595		018601 *	
<b>SB</b> 6 Šedo biela RAL 9002	65,00	<b>78,00</b>	65,00	<b>78,00</b>	133,50	<b>160,20</b>
	018762 *		018779		018786	
<b>BH</b> 7 Bielo hliníková RAL 9006	65,00	<b>78,00</b>	65,00	<b>78,00</b>	133,50	<b>160,20</b>
	018526		018533		018540	
<b>PS</b> 8 Prachovo šedá RAL 7037	65,00	<b>78,00</b>	65,00	<b>78,00</b>	133,50	<b>160,20</b>
	018731 *		018748		018755 *	
<b>MM</b> 9 Metalická medená RAL extra	65,00	<b>78,00</b>	65,00	<b>78,00</b>	133,50	<b>160,20</b>
	018618 *		018625 *		018632 *	
<b>BHT – P.20</b> 10 Bielo hliníková tmavá RAL 9007	65,00	<b>78,00</b>	65,00	<b>78,00</b>	133,50	<b>160,20</b>
	095527 *		095534 *		095541 *	
<b>MZ</b> 11 Machovo zelená RAL 6005	65,00	<b>78,00</b>	65,00	<b>78,00</b>	133,50	<b>160,20</b>
	018670 *		018687		018694 *	
<b>MOT</b> 12 Tmavo modrá RAL 5010	65,00	<b>78,00</b>	65,00	<b>78,00</b>	133,50	<b>160,20</b>
	018649 *		018656 *		018663 *	
<b>TZ</b> 13 Trávovo zelená RAL 6011	65,00	<b>78,00</b>	65,00	<b>78,00</b>	133,50	<b>160,20</b>
	018823 *		018830 *		018847 *	
<b>Balenie v ks</b> 	<b>1</b>		<b>1</b>		<b>1</b>	
<b>Balenie v ks</b> 	<b>60</b>		<b>60</b>		<b>60</b>	

\* Výroba na objednávku





## OCHRANNÁ RÚRA S REVÍZNYM OTVOROM

P-POZR



Menovitá veľkosť	80		100		100	
	1,0		1,0		1,5	
Dĺžka v m	1,0		1,0		1,5	
Cena v €/m	Bez DPH	S DPH	Bez DPH	S DPH	Bez DPH	S DPH
<b>TM</b> 1 Testa di Moro RAL 8028	64,00	<b>76,80</b>	49,00	<b>58,80</b>	97,00	<b>116,40</b>
	010254 *		010261		010278	
<b>AN</b> 2 Antracit RAL 7016	64,00	<b>76,80</b>	49,00	<b>58,80</b>	97,00	<b>116,40</b>
	009760 *		009777		009784 *	
<b>IC</b> 3 Intenzívna čierna RAL 9005	64,00	<b>76,80</b>	49,00	<b>58,80</b>	97,00	<b>116,40</b>
	009869 *		009876		009883 *	
<b>OC</b> 4 Oceľovo červená RAL 3009	64,00	<b>76,80</b>	49,00	<b>58,80</b>	97,00	<b>116,40</b>
	010117 *		010124 *		010131 *	
<b>MH</b> 5 Medeno hnedá RAL 8004	64,00	<b>76,80</b>	49,00	<b>58,80</b>	97,00	<b>116,40</b>
	009913 *		009920 *		009937 *	
<b>SB</b> 6 Šedo biela RAL 9002	64,00	<b>76,80</b>	49,00	<b>58,80</b>	97,00	<b>116,40</b>
	010209 *		010247 *		010216 *	
<b>BH</b> 7 Bielo hliníková RAL 9006	64,00	<b>76,80</b>	49,00	<b>58,80</b>	97,00	<b>116,40</b>
	009814 *		009821 *		009838 *	
<b>PS</b> 8 Prachovo šedá RAL 7037	64,00	<b>76,80</b>	49,00	<b>58,80</b>	97,00	<b>116,40</b>
	010162 *		010179 *		010186 *	
<b>MM</b> 9 Metalická medená RAL extra	64,00	<b>76,80</b>	49,00	<b>58,80</b>	97,00	<b>116,40</b>
	009968 *		009975 *		009982 *	
<b>BHT – P.20</b> 10 Bielo hliníková tmavá RAL 9007	64,00	<b>76,80</b>	49,00	<b>58,80</b>		
	096494 *		096500 *			
<b>MZ</b> 11 Machovo zelená RAL 6005	64,00	<b>76,80</b>	49,00	<b>58,80</b>	97,00	<b>116,40</b>
	010063 *		010070 *		010087 *	
<b>MOT</b> 12 Tmavo modrá RAL 5010	64,00	<b>76,80</b>	49,00	<b>58,80</b>	97,00	<b>116,40</b>
	010018 *		010025 *		010032 *	
<b>TZ</b> 13 Trávovo zelená RAL 6011	64,00	<b>76,80</b>	49,00	<b>58,80</b>	97,00	<b>116,40</b>
	010308 *		010315 *		010322 *	
<b>Balenie v ks</b>	<b>1</b>		<b>1</b>		<b>1</b>	
<b>Balenie v ks</b>	<b>70</b>		<b>60</b>		<b>60</b>	

\* Výroba na objednávku

## OCHRANNÁ RÚRA S REVÍZNYM OTVOROM



P-POZR

Menovitá veľkosť	120		120	
	Dĺžka v m		1,5	
Cena v €/m	Bez DPH	S DPH	Bez DPH	S DPH
	<b>TM</b> 1 Testa di Moro RAL 8028	115,00	<b>138,00</b>	165,00
	010285		010292 *	
<b>AN</b> 2 Antracit RAL 7016	115,00	<b>138,00</b>	165,00	<b>198,00</b>
	009791 *		009807 *	
<b>IC</b> 3 Intenzívna čierna RAL 9005	115,00	<b>138,00</b>	165,00	<b>198,00</b>
	009890 *		009906 *	
<b>OC</b> 4 Oceľovo červená RAL 3009	115,00	<b>138,00</b>	165,00	<b>198,00</b>
	010148 *		010155 *	
<b>MH</b> 5 Medeno hnedá RAL 8004	115,00	<b>138,00</b>	165,00	<b>198,00</b>
	009944 *		009951 *	
<b>SB</b> 6 Šedo biela RAL 9002	115,00	<b>138,00</b>	165,00	<b>198,00</b>
	010223 *		010230 *	
<b>BH</b> 7 Bielo hliníková RAL 9006	115,00	<b>138,00</b>	165,00	<b>198,00</b>
	009845 *		009852 *	
<b>PS</b> 8 Prachovo šedá RAL 7037	115,00	<b>138,00</b>	165,00	<b>198,00</b>
	010193 *		009753 *	
<b>MM</b> 9 Metalická medená RAL extra	115,00	<b>138,00</b>	165,00	<b>198,00</b>
	009999 *		010001 *	
<b>BHT – P.20</b> 10 Bielo hliníková tmavá RAL 9007	115,00	<b>138,00</b>		
	096517 *			
<b>MZ</b> 11 Machovo zelená RAL 6005	115,00	<b>138,00</b>	165,00	<b>198,00</b>
	010094 *		010100 *	
<b>MOT</b> 12 Tmavo modrá RAL 5010	115,00	<b>138,00</b>	165,00	<b>198,00</b>
	010049 *		010056 *	
<b>TZ</b> 13 Trávovo zelená RAL 6011	115,00	<b>138,00</b>	165,00	<b>198,00</b>
	010339 *		010346 *	
<b>Balenie v ks</b> 	1		1	
<b>Balenie v ks</b> 	40		40	

\* Výroba na objednávku

## OBJÍMKA S REBROVOU GUMOU M10

P-POB-OZR



Menovitá veľkosť	EAN číslo výrobku	Balenie v ks		Cena [€/ks]	
				Bez DPH	S DPH
80	002525	25	1 250	1,58	<b>1,90</b>
100	002532	25	1 250	2,00	<b>2,40</b>
120	002549	20	1 000	2,26	<b>2,71</b>

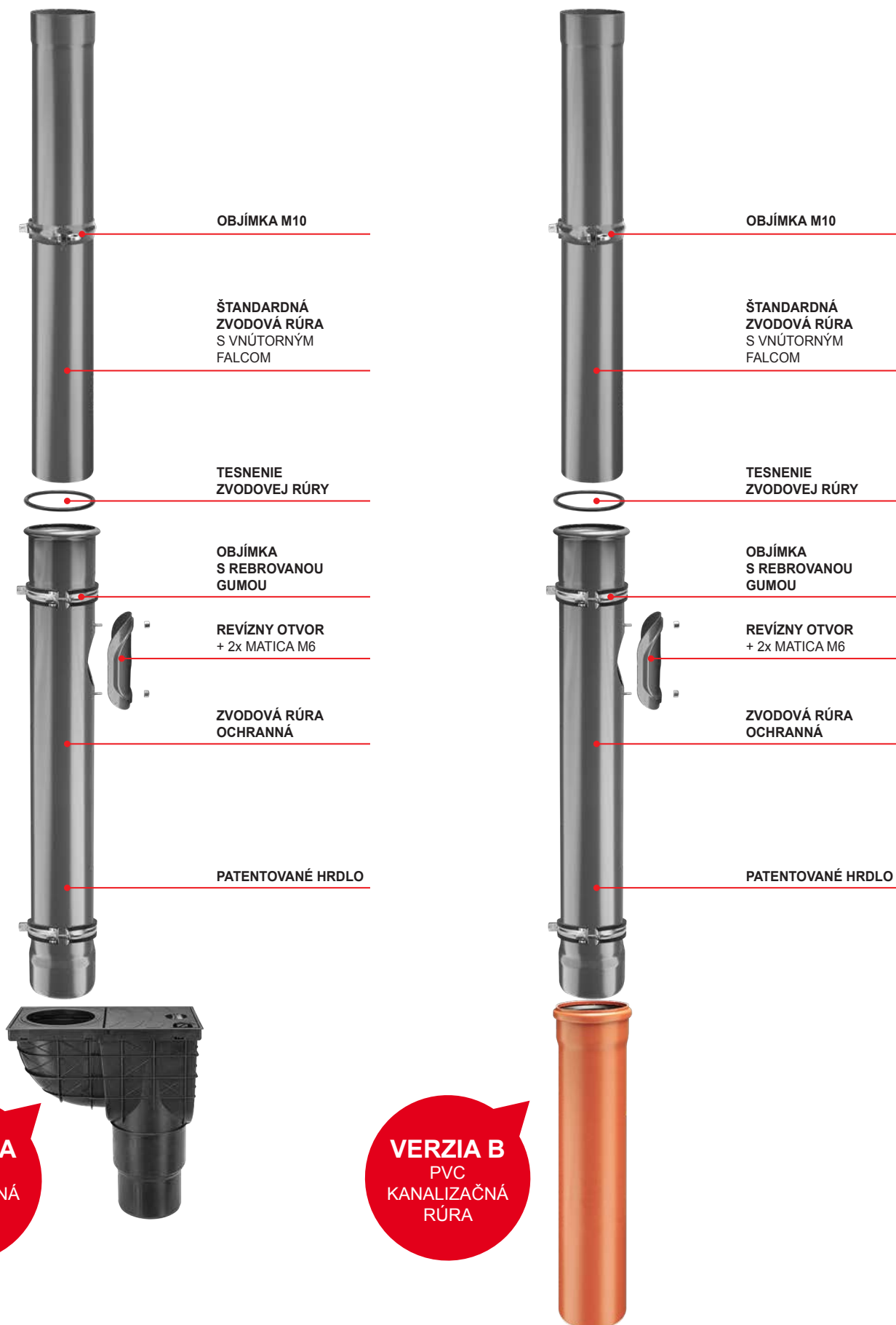



## ŽABIA PAPUĽA ODVETRANIE HREBEŇA

WO-ZP VFR

Menovitá veľkosť	222 x 305	
Cena v €/ks	Bez DPH	S DPH
<b>TM</b> 1 Testa di Moro RAL 8028	17,50	21,00
		091482 *
<b>AN</b> 2 Antracit RAL 7016	17,50	21,00
		091383 *
<b>IC</b> 3 Intenzívna čierna RAL 9005	17,50	21,00
		091406 *
<b>OC</b> 4 Oceľovo červená RAL 3009	17,50	21,00
		091451 *
<b>MH</b> 5 Medeno hnedá RAL 8004	17,50	21,00
		091413 *
<b>SB</b> 6 Šedo biela RAL 9002	17,50	21,00
		091475 *
<b>BH</b> 7 Bielo hliníková RAL 9006	17,50	21,00
		091390 *
<b>PS</b> 8 Prachovo šedá RAL 7037	17,50	21,00
		091468 *
<b>MM</b> 9 Metalická medená RAL extra	17,50	21,00
		091420 *
<b>BHT</b> 10 Bielo hliníková tmavá RAL 9007		
<b>MZ</b> 11 Machovo zelená RAL 6005	17,50	21,00
		091444 *
<b>MOT</b> 12 Tmavo modrá RAL 5010	17,50	21,00
		091437 *
<b>TZ</b> 13 Trávovo zelená RAL 6011	17,50	21,00
		091499 *
<b>Balenie v ks</b> 		1
<b>Balenie v ks</b> 		-

\* Výroba na objednávku

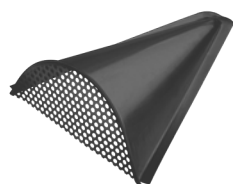

## ŠPIRÁLOVÝ VRTÁK DO KOVU

## KNS-GBL VRT. OBOJ.



Menovitá veľkosť	EAN číslo výrobku	Balenie v ks		Cena [€/ks]	
				Bez DPH	S DPH
3,3	008428	10	–	1,00	1,20
4,2	008435	10	–	1,15	1,38

## NITOVACIE KLIŠTE

## KNS-KLSN GESIPA



Menovitá veľkosť	EAN číslo výrobku	Balenie v ks		Cena [€/ks]	
				Bez DPH	S DPH
–	063366	1	–	45,00	54,00

## LEPIACI A TESNIACI TMEL

## SCH-SIKAFLEX CC



Objem	EAN číslo výrobku	Balenie v ks		Cena [€/ks]	
				Bez DPH	S DPH
290	064578	12	1 344	7,10	8,52

## LEPIACI A TESNIACI TMEL

## SCH-SIKAFLEX 11FC



Objem	EAN číslo výrobku	Balenie v ks		Cena [€/ks]	
				Bez DPH	S DPH
300	064622	12	1 344	8,05	9,66
300	064592	12	1 344	8,05	9,66
300	064608	12	1 344	8,05	9,66
300	064615	12	1 344	8,05	9,66
300	064585	12	1 344	8,05	9,66

## ŠPECIÁLNY TMEL PRE KLAMPIAROV

## SCH-SPENGLER 390



Objem	EAN číslo výrobku	Balenie v ks		Cena [€/ks]	
				Bez DPH	S DPH
310	008596	20	1 200	6,00	7,20

## PLASTICKÁ ČIERNA STIERKOVÁ HMOTA

## SCH-ENKE ENKOLIT



Menovitá hmotnosť	EAN číslo výrobku	Balenie v kg		Cena [€/kg]	
				Bez DPH	S DPH
11 kg	010360	11	495	5,85	7,02

