



**SPOJOVACÍ
MATERIÁL**



- **NITY**
5 Trhacie nity
- **SKRUTKY**
9 Klampiarska skrutka
- **KLINCE**
11 Klince
- **HMOŽDINKY**
14 Hmoždinka natĺkacia
- **SKRUTKY**
14 Samorezná skrutka
15 Skrutka farmárska
17 Skrutka samovrtná
- **KALOTY**
19 Kalota ORKAN pre TR 18
19 Kalota ORKAN pre TR 18
19 Kalota ORKAN pre TR 35
19 Kalota ORKAN pre TR 35
- **SPOJOVACÍ MATERIÁL MIX**
21 Samovrtná skrutka pozinkovaná do ocele
21 Samovrtná skrutka pozinkovaná do dreva
21 Tanierová podložka
21 Pozinkovaná skrutka DABO
- **MONTÁŽNE KRYTKY**
22 Krytka montážna pozinkovaná
22 Krytka montážna titánzinková
22 Krytka montážna medená
22 Krytka montážna hliníková
- **NEREZOVÉ PRÍPONKY**
24 Nerezová príponka pevná
24 Nerezová príponka posuvná 55
24 Nerezová príponka posuvná 70
24 Nerezová príponka nohavicová
24 Nerezová príponka nohavicová posuvná

Dvojdielny trhací nit sa skladá z puzdra, ktoré je nasadené na trňi. Pri montáži stačí, aby boli spájané diely prístupné iba z jednej strany. Montáž trhacieho nitu sa vykonáva zatahnutím trňa nitovacími kliešťami (Nitovačky), pričom hlava trňa je vtiahnutá do puzdra nitu, ktoré rozšírením vytvorí hlavu.

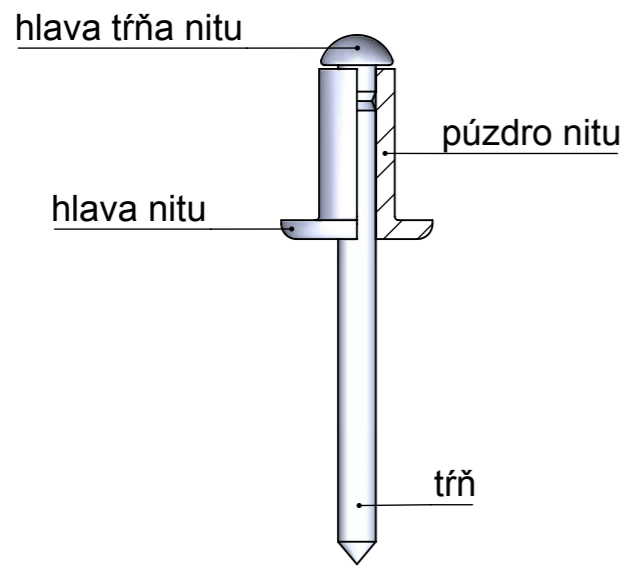

Otvorený trhací nit

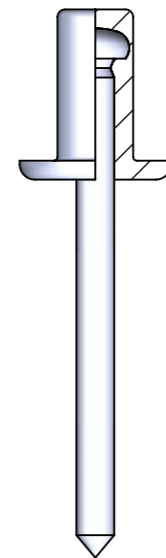

Uzavretý trhací nit

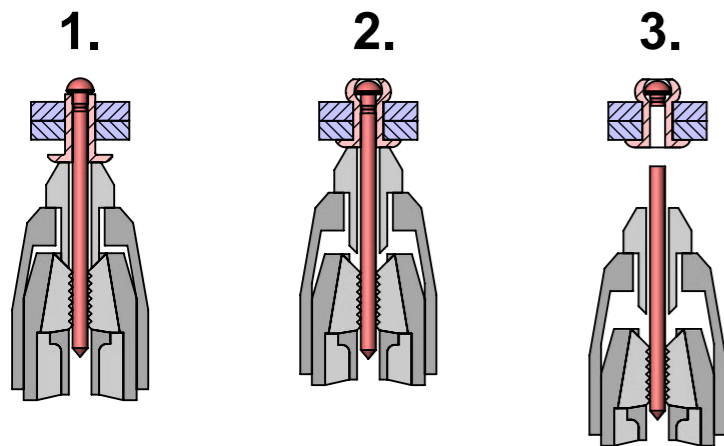

MONTÁŽ TRHACIEHO NITU:

1. Trhací nit vložte trňom do nitovačky a zastrčte do otvoru.
2. Zapnutím zdvihu nitovačky je trň nitu uchopený a vtiahnutý čelust'ami. Hlava trňa tvaruje koniec puzdra. Proces je ukončený, keď hlava trňa dosiahne povrch pripojovaného dielu.
3. Táto pozícia je spojená s veľkým nárastom sily, pri ktorej dosiahnutí sa trň nitu odtrhne v presne definovanom mieste. Odtrhnutý nit je odstránený, a zvyšná časť zostane v nite.

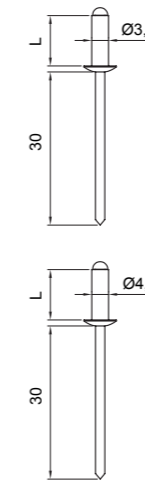

SM-NO – POZINKOVANÝ TRHACÍ NIT

Menovitá veľkosť v mm	Balenie v ks		Objednávkové číslo	Cena s DPH/balenie
3,2 x 6	100 ks	–	019653	2,40 €
3,2 x 8	100 ks	–	019660	2,52 €
3,2 x 10	100 ks	–	019677	3,42 €
3,2 x 12	100 ks	–	019684	3,66 €
4,0 x 6	100 ks	–	019691	3,60 €
4,0 x 8	100 ks	–	019707	4,02 €
4,0 x 10	100 ks	–	019714	4,32 €
4,0 x 12	100 ks	–	019721	4,62 €

001

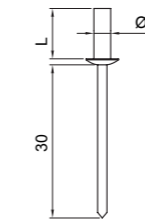

SM-NOP-VT – POZINKOVANÝ TRHACÍ NIT VODOTESNÝ

Menovitá veľkosť v mm	Balenie v ks		Objednávkové číslo	Cena s DPH/balenie
4,0 x 10	100 ks	–	061225	14,40 €

002

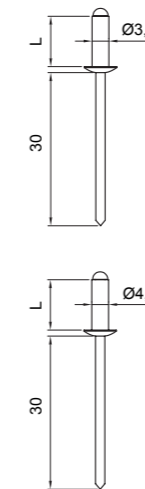

SM-MNO – MEDENÝ TRHACÍ NIT

Menovitá veľkosť v mm	Balenie v ks		Objednávkové číslo	Cena s DPH/balenie
3,2 x 6	100 ks	–	049100	4,44 €
3,2 x 8	100 ks	–	049117	4,62 €
3,2 x 10	100 ks	–	049124	4,92 €
3,2 x 12	100 ks	–	049131	5,46 €
4,0 x 6	100 ks	–	049148	5,52 €
4,0 x 8	100 ks	–	049155	6,00 €
4,0 x 10	100 ks	–	049162	6,60 €
4,0 x 12	100 ks	–	049179	7,44 €

003

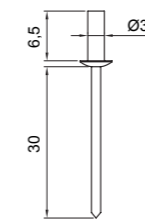

SM-MNOP-VT – MEDENÝ TRHACÍ NIT VODOTESNÝ

Menovitá veľkosť v mm	Balenie v ks		Objednávkové číslo	Cena s DPH/balenie
3,2 x 6,5	100 ks	–	051042	8,16 €

004



SM-NNO – NEREZOVÝ TRHACÍ NIT

Menovitá veľkosť v mm	Balenie v ks		Objednávkové číslo	Cena s DPH/balenie
3,2 x 6	100 ks	-	061232	8,40 €
3,2 x 8	100 ks	-	061249	9,00 €
3,2 x 10	100 ks	-	061256	10,80 €
4,0 x 6	100 ks	-	061263	10,20 €
4,0 x 8	100 ks	-	061270	11,40 €
4,0 x 10	100 ks	-	061287	12,00 €

005

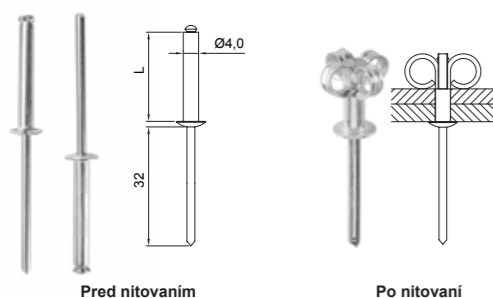

SM-HNO-K – HLINÍKOVÝ TRHACÍ NIT – KVET

Menovitá veľkosť v mm	Balenie v ks		Objednávkové číslo	Cena s DPH/ks
4,0 x 20	50 ks	-	062857	0,060 €
4,0 x 25	50 ks	-	062864	0,066 €

006

SM-HNR – HLINÍKOVÝ ROZPERNÝ NIT

Menovitá veľkosť v mm	Balenie v ks		Objednávkové číslo	Cena s DPH/ks
4,8 x 30	250 ks	-	064059	€
4,8 x 40	250 ks	-	064066	€

007

SM-HNO – HLINÍKOVÝ TRHACÍ NIT

Menovitá veľkosť v mm	Balenie v ks		Objednávkové číslo	Cena s DPH/ks
4,0 x 8	100 ks	-	062871	0,024 €
4,0 x 10	100 ks	-	062888	0,030 €
4,0 x 12	100 ks	-	062895	0,036 €
4,0 x 20	50 ks	-	062901	0,048 €

008

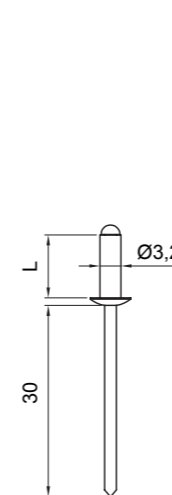

SM-NO – POZINKOVANÝ TRHACÍ NIT FARBENÝ

Menovitá veľkosť v mm	3,2 x 6		3,2 x 8		3,2 x 10	
Balenie	-	100	-	100	-	100
Obj. číslo / Cena		Cena s DPH/ks		Cena s DPH/ks		Cena s DPH/ks
1. skupina farieb	TM	062024 0,042 €	062031 0,048 €	062048 0,060 €		
	AN	061294 0,042 €	061300 0,048 €	061317 0,060 €		
	IC	061560 0,042 €	061577 0,048 €	061584 0,060 €		
	OC	061843 0,042 €	061850 0,048 €	061867 0,060 €		
	MH	061621 0,042 €	061638 0,048 €	061645 0,060 €		
2. skupina farieb	SB	061966 0,042 €	061973 0,048 €	061980 0,060 €		
	PS	061904 0,042 €	061911 0,048 €	061928 0,060 €		
	BH	061423 0,042 €	061430 0,048 €	061447 0,060 €		
	BHT	061492 0,042 €	061508 0,048 €	061515 0,060 €		
	B	061355 0,042 €	061362 0,048 €	061379 0,060 €		
	MM	061683 0,042 €	061690 0,048 €	061706 0,060 €		
	MZ	061799 0,042 €	061805 0,048 €	061812 0,060 €		
	MOT	061737 0,042 €	061744 0,048 €	061751 0,060 €		
	TZ	062086 0,042 €	062093 0,048 €	062109 0,060 €		

009

SM-NO – POZINKOVANÝ TRHACÍ NIT FARBENÝ

Menovitá veľkosť v mm	4,0 x 6		4,0 x 8		4,0 x 10		4,0 x 12	
Balenie	-	100	-	100	-	100	-	100
Obj. číslo / Cena		Cena s DPH/ks		Cena s DPH/ks		Cena s DPH/ks		Cena s DPH/ks
1. skupina farieb	TM	062055 0,060 €	062062 0,066 €	062079 0,066 €	-	-	-	-
	AN	061324 0,060 €	061331 0,066 €	061348 0,066 €	-	-	-	-
	IC	061591 0,060 €	061607 0,066 €	061614 0,066 €	-	-	-	-
	OC	061874 0,060 €	061881 0,066 €	061898 0,066 €	-	-	-	-
	MH	061652 0,060 €	061669 0,066 €	061676 0,066 €	-	-	-	-
2. skupina farieb	SB	061997 0,060 €	062000 0,066 €	062017 0,066 €	-	-	-	-
	PS	061935 0,060 €	061942 0,066 €	061959 0,066 €	-	-	-	-
	BH	061454 0,060 €	061461 0,066 €	061478 0,066 €	061485 0,072 €			
	BHT	061522 0,060 €	061539 0,066 €	061546 0,066 €	061553 0,072 €			
	B	061386 0,060 €	061393 0,066 €	061409 0,066 €	061416 0,072 €			
	MM	061713 0,060 €	061720 0,066 €	062147 0,066 €	-	-	-	-
	MZ	061829 0,060 €	061836 0,066 €	062154 0,066 €	-	-	-	-
	MOT	061768 0,060 €	061775 0,066 €	061782 0,066 €	-	-	-	-
	TZ	062116 0,060 €	062123 0,066 €	062130 0,066 €	-	-	-	-

010

SM-HNO – HLINÍKOVÝ TRHACÍ NIT FARBENÝ

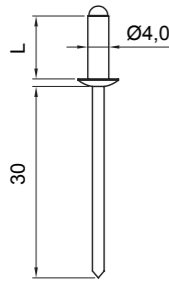

Menovitá veľkosť v mm	4,0 x 8		4,0 x 10		Obj. číslo / Cena	Cena s DPH/ks	Cena s DPH/ks	Cena s DPH/ks	
	📦	🚚	📦	🚚					
Balenie	-	100	-	100	-	-	-	-	
1. skupina farieb	AN	062574	0,048 €	062581	0,054 €				
	TM	062796	0,048 €	062802	0,054 €				
	SS	062772	0,048 €	062789	0,054 €				
	ZH	062819	0,048 €	062826	0,054 €				
	MH	062697	0,048 €	062703	0,054 €				
	2. skupina farieb	BH	062611	0,048 €	062628	0,054 €			
		IC	062673	0,048 €	062680	0,054 €			
		OC	062734	0,048 €	062741	0,054 €			
		MZ	062710	0,048 €	062727	0,054 €			
		B	062598	0,048 €	062604	0,054 €			
		ZS	062833	0,048 €	062840	0,054 €			
		BHT	062635	0,048 €	062642	0,054 €			
		HM	062659	0,048 €	062666	0,054 €			
		OZ	062758	0,048 €	062765	0,054 €			

011

SM-OKSP-P15 – KLAMPIARSKA SKRUTKA MEDENÁ

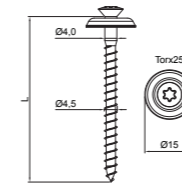

Menovitá veľkosť v mm	Balenie v ks		Objednávkové číslo	Cena s DPH/balenie
	📦	🚚		
4,5x25	50 ks	-	007544	9,48 €
4,5x35	50 ks	-	007551	10,80 €
4,5x45	25 ks	-	007568	6,24 €
4,5x55	25 ks	-	007575	8,22 €
4,5x65	25 ks	-	007582	9,60 €
4,5x80	25 ks	-	007599	12,24 €
4,5x100	20 ks	-	007605	12,36 €

015

SM-OKSP-P19 – KLAMPIARSKA SKRUTKA MEDENÁ

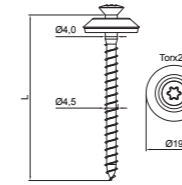

Menovitá veľkosť v mm	Balenie v ks		Objednávkové číslo	Cena s DPH/balenie
	📦	🚚		
4,5x25	25 ks	-	007612	6,24 €
4,5x35	25 ks	-	007629	6,78 €
4,5x45	25 ks	-	007636	7,92 €
4,5x55	25 ks	-	007643	9,06 €
4,5x65	20 ks	-	007650	7,68 €
4,5x80	15 ks	-	007667	8,52 €
4,5x100	10 ks	-	007674	6,60 €

016

KNS – VRTÁK OBOJSTRANNÝ ŠPIRÁLOVÝ DO KOVU



Menovitá veľkosť v mm	Balenie v ks		Objednávkové číslo	Cena s DPH/ks
	📦	🚚		
3,3	10 ks	-	008428	1,020 €
4,2	10 ks	-	008435	1,200 €
5,2	10 ks	-	008442	2,340 €

012

KNS-KLSN – NITOVACIE KLIŠTE



Menovitá veľkosť v mm	Balenie v ks		Objednávkové číslo	Cena s DPH/ks
	📦	🚚		
GBL GO-101	1 ks	-	063359	13,20 €

013

KNS-KLSN – NITOVACIE KLIŠTE GESIPA



Menovitá veľkosť v mm	Balenie v ks		Objednávkové číslo	Cena s DPH/ks
	📦	🚚		
GESIPA	1 ks	-	063366	48,00 €

014



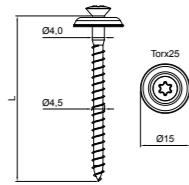

SM-OXSN-P15 – KLAMPIARSKA SKRUTKA NEREZOVÁ

Menovitá veľkosť v mm	Balenie v ks		Objednávkové číslo	Cena s DPH/balenie
4,5x25	50 ks	–	007407	8,52 €
4,5x35	50 ks	–	007414	9,00 €
4,5x45	25 ks	–	007421	5,46 €
4,5x55	25 ks	–	007438	6,00 €
4,5x65	25 ks	–	007445	7,26 €
4,5x80	25 ks	–	007452	8,28 €
4,5x100	20 ks	–	007469	8,28 €

017

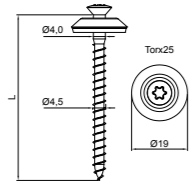

SM-OXSN-P19 – KLAMPIARSKA SKRUTKA NEREZOVÁ

Menovitá veľkosť v mm	Balenie v ks		Objednávkové číslo	Cena s DPH/balenie
4,5x25	25 ks	–	007476	5,76 €
4,5x35	25 ks	–	007483	6,00 €
4,5x45	25 ks	–	007490	6,72 €
4,5x55	25 ks	–	007506	7,44 €
4,5x65	20 ks	–	007513	6,60 €
4,5x80	15 ks	–	007520	6,12 €
4,5x100	10 ks	–	007537	4,80 €

018

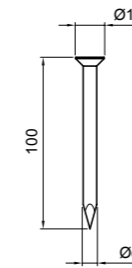

SM-KCK-H11 – POZINKOVANÝ KLÍNEC DO HÁKU

Menovitá veľkosť v mm	Balenie v kg		Objednávkové číslo	Cena s DPH/kg
50/63	2,5 kg	–	062918	2,46 €
50/80	2,5 kg	–	062925	2,46 €
50/100	2,5 kg	–	062932	2,46 €

019

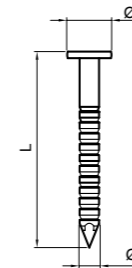

SM-KCPB-K – POZINKOVANÝ KLÍNEC KONVEXNÝ

Menovitá veľkosť v mm	Balenie v kg		Objednávkové číslo	Cena s DPH/kg
3,6/4,2x32	2,5 kg	–	062949	2,82 €
3,6/4,2x36	2,5 kg	–	062956	2,82 €

020

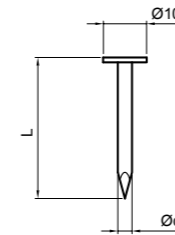

SM-KCPB-H8 – POZINKOVANÝ KLÍNEC LEPENKOVÝ

Menovitá veľkosť v mm	Balenie v kg		Objednávkové číslo	Cena s DPH/kg
25/25	2,5 kg	–	062963	2,82 €
25/32	2,5 kg	–	062970	2,82 €
25/36	2,5 kg	–	062987	2,82 €
28/40	2,5 kg	–	062994	2,82 €

021



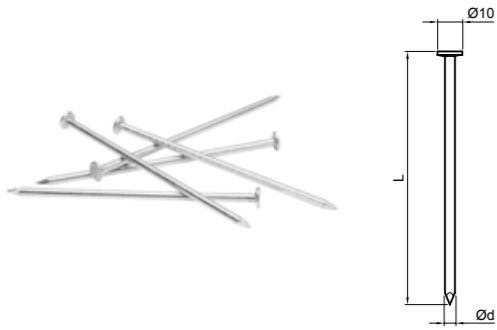

SM-KCSS-V10 – POZINKOVANÝ KLÍNEC STAVEBNÝ

Menovitá veľkosť v mm	Balenie v kg		Objednávkové číslo	Cena s DPH/kg
28/63	2,5 kg	–	063007	2,40 €
31/80	2,5 kg	–	063014	2,40 €
34/90	2,5 kg	–	063021	2,40 €
40/100	2,5 kg	–	063038	2,40 €
40/120	2,5 kg	–	063045	2,40 €

022

SM-OKCSS-V10 – OCEĽOVÝ KLÍNEC STAVEBNÝ

Menovitá veľkosť v mm	Balenie v kg		Objednávkové číslo	Cena s DPH/kg
28/63	5,0 kg	–	063052	1,50 €
28/70	5,0 kg	–	063069	1,50 €
31/80	5,0 kg	–	063076	1,50 €
35/90	5,0 kg	–	063083	1,50 €
40/100	5,0 kg	–	063090	1,50 €
40/120	5,0 kg	–	063106	1,50 €
45/130	5,0 kg	–	063113	1,50 €
50/150	5,0 kg	–	063120	1,50 €
63/180	5,0 kg	–	063137	1,50 €
70/200	5,0 kg	–	063144	1,58 €
71/220	5,0 kg	–	063151	1,58 €
76/240	5,0 kg	–	063168	1,58 €
76/250	5,0 kg	–	063175	1,58 €
88/280	5,0 kg	–	063182	1,58 €
88/300	5,0 kg	–	063199	1,58 €

023

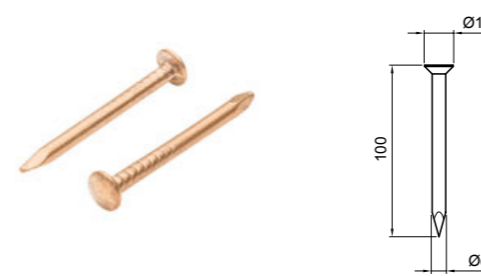
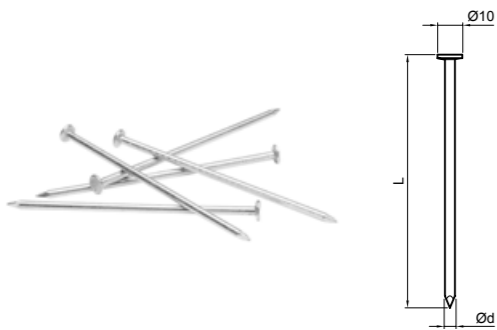

SM-MKCK-H11 – MEDENÝ KLÍNEC DO HÁKU

Menovitá veľkosť v mm	Balenie v ks		Objednávkové číslo	Cena s DPH/balenie
45/80	25 ks	–	063380	7,20 €
45/100	25 ks	–	063397	8,04 €

024

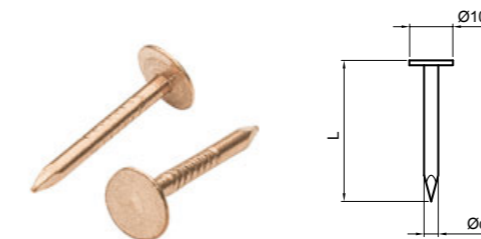

SM-MKCP-H10 – MEDENÝ KLÍNEC LEPENKOVÝ

Menovitá veľkosť v mm	Balenie v ks		Objednávkové číslo	Cena s DPH/balenie
28/25	100 ks	–	063403	7,20 €
28/30	100 ks	–	063410	7,20 €
28/35	100 ks	–	063427	7,20 €
28/40	100 ks	–	063434	7,20 €

025



SM-MKCP-P-H6 – MEDENÝ KLÍNEC S POLGULĽATOU HLAVOU

Menovitá veľkosť v mm	Balenie v ks		Objednávkové číslo	Cena s DPH/balenie
25/25	200 ks	–	063441	6,60 €
25/30	200 ks	–	063458	6,60 €
25/35	200 ks	–	063465	7,20 €

026

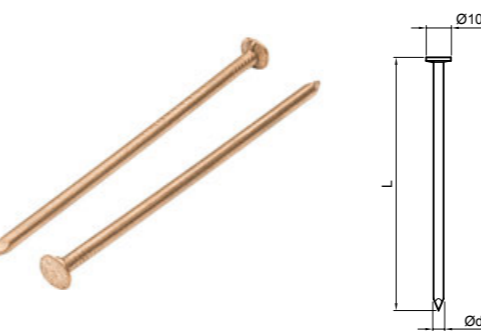

SM-MKCSS-V10 – MEDENÝ KLÍNEC STAVEBNÝ

Menovitá veľkosť v mm	Balenie v ks		Objednávkové číslo	Cena s DPH/balenie
31/80	50 ks	–	063472	7,20 €
40/100	25 ks	–	063489	7,20 €

027



SM-HNDQ – HMOŽDINKA NATLÁKACIA RÝCHLA

Menovitá veľkosť v mm	Balenie v ks		Objednávkové číslo	Cena s DPH/ks
SP 6x40	200 ks	–	008640	0,042 €
SP 6x55	200 ks	–	008657	0,072 €
SP 6x70	100 ks	–	008664	0,096 €
SP 6x80	100 ks	–	008671	0,102 €
SP 8x70	100 ks	–	008688	0,150 €
SP 8x100	100 ks	–	008695	0,240 €

028

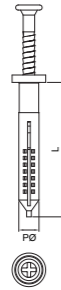

SM-HNDQ – HMOŽDINKA NATLÁKACIA RÝCHLA FIX

Menovitá veľkosť v mm	Balenie v ks		Objednávkové číslo	Cena s DPH/ks
TF 6x40	200 ks	–	008701	0,080 €

029

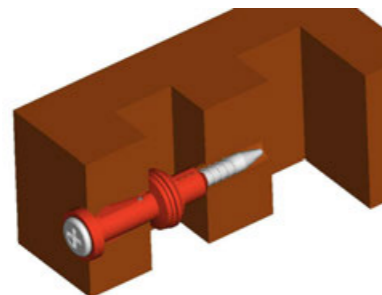

Zaskrutkovanie „uzlovanie“ v dutej tehle

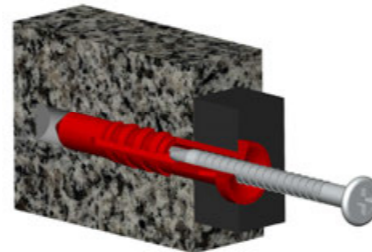

Natĺkanie v plnom tvrdom materiáli

SM-GBL – SAMOREZNÁ SKRUTKA POZINKOVANÁ

Menovitá veľkosť v mm	Balenie v ks		Objednávkové číslo	Cena s DPH/ks
4,2x13	1000 ks	–	063533	0,013 €
4,2x16	1000 ks	–	063540	0,016 €
4,2x19	1000 ks	–	063557	0,018 €
4,2x25	500 ks	–	064073	– €
4,8x16	1000 ks	–	064080	– €
4,8x19	1000 ks	–	064097	– €
4,8x25	500 ks	–	063564	0,029 €

030

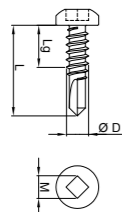

KNS – NÁDSTAVEC S MAGNETOM

Menovitá veľkosť v mm	Balenie v ks		Objednávkové číslo	Cena s DPH/ks
GBL SW8	1 ks	–	063373	3,120 €

031

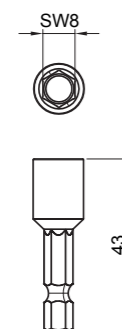

SM-SKF – KJG POZINKOVANÁ SKRUTKA FARMÁRSKA

Menovitá veľkosť v mm	Balenie v ks		Objednávkové číslo	Cena s DPH
4,8x20	250 ks	2000 ks	054210	0,054 €
4,8x35	250 ks	2000 ks	054227	0,054 €
4,8x60	100 ks	800 ks	054234	0,120 €
4,8x70	100 ks	800 ks	054241	0,132 €
4,8x80	100 ks	800 ks	054258	0,156 €

032

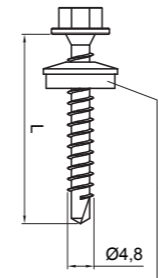

SM-SKF – KJG POZINKOVANÁ SKRUTKA FARMÁRSKA, FARBENÁ

Menovitá veľkosť v mm	4,8x20		4,8x35		4,8x60		
Kýblik							
Kartón	250	2000	250	2000	100	800	
Obj. číslo / Cena		Cena s DPH		Cena s DPH		Cena s DPH	
1. skupina farieb	TM	054807	0,054 €	054814	0,054 €	054821	0,120 €
	AN	054265	0,054 €	054272	0,054 €	054289	0,120 €
	IC	054418	0,054 €	054425	0,054 €	054432	0,120 €
	OC	054593	0,054 €	054609	0,054 €	054616	0,120 €
	MH	054470	0,054 €	054487	0,054 €	054494	0,120 €
	TH	054777	0,054 €	054784	0,054 €	054791	0,120 €
2. skupina farieb	SB	054715	0,054 €	054722	0,054 €	054739	0,120 €
	BH	054326	0,054 €	054333	0,054 €	054340	0,120 €
	PS	054654	0,054 €	054661	0,054 €	054678	0,120 €
	BHT	054357	0,054 €	054364	0,054 €	054371	0,120 €
	MM	054500	0,054 €	054517	0,054 €	054524	0,120 €
	MZ	054562	0,054 €	054579	0,054 €	054586	0,120 €
3. skupina farieb	MOT	054531	0,054 €	054548	0,054 €	054555	0,120 €
	TZ	054838	0,054 €	054845	0,054 €	054852	0,120 €
	B	054296	0,054 €	054302	0,054 €	054319	0,120 €
	LS	054449	0,054 €	054456	0,054 €	054463	0,120 €
	PC	054623	0,054 €	054630	0,054 €	054647	0,120 €
	SK	054746	0,054 €	054753	0,054 €	054760	0,120 €
HC	054388	0,054 €	054395	0,054 €	054401	0,120 €	
RC	054685	0,054 €	054692	0,054 €	054708	0,120 €	

033

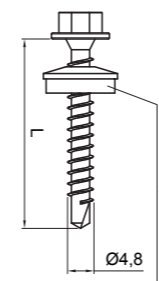

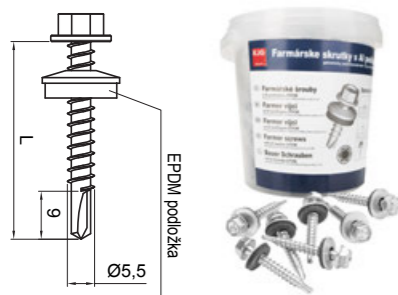

SM-GT5 – KJG POZINKOVANÁ SAMOVRTNÁ SKRUTKA

Menovitá veľkosť v mm	Balenie v ks		Objednávkové číslo	Cena s DPH
	250 ks	2000 ks		
5,5x19	250 ks	2000 ks	063700	0,066 €
5,5x25	250 ks	2000 ks	063717	0,072 €
5,5x32	250 ks	2000 ks	063724	0,090 €

034



SM-GT5 – KJG POZINKOVANÁ SAMOVRTNÁ SKRUTKA, FARBENÁ

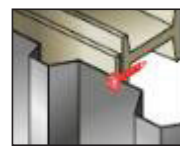
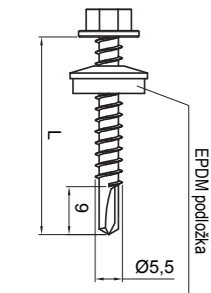

Menovitá veľkosť v mm	5,5x19		5,5x25		5,5x32	
	Kýblik	Kartón	Kýblik	Kartón	Kýblik	Kartón
Obj. číslo / Cena	Kýblik	Cena s DPH	Kýblik	Cena s DPH	Kýblik	Cena s DPH
1. skupina farieb	TM	064028 0,090 €	064035 0,096 €	064042 0,108 €		
	AN	063731 0,090 €	063748 0,096 €	063755 0,108 €		
	IC	063854 0,090 €	063861 0,096 €	063878 0,108 €		
	OC	063953 0,090 €	063960 0,096 €	063977 0,108 €		
	MH	063885 0,090 €	063892 0,096 €	063908 0,108 €		
	TH	- - €	- - €	- - €		
	SB	063991 0,090 €	064004 0,096 €	064011 0,108 €		
2. skupina farieb	BH	063793 0,090 €	063809 0,096 €	063816 0,108 €		
	PS	- - €	- - €	063984 0,108 €		
	BHT	063823 0,090 €	063830 0,096 €	063847 0,108 €		
	MM	- - €	- - €	063915 0,108 €		
	MZ	- - €	- - €	063946 0,108 €		
	MOT	- 0,000 €	063922 0,096 €	063939 0,108 €		
	TZ	- - €	- - €	- - €		
3. skupina farieb	B	063762 0,090 €	063779 0,096 €	063786 0,108 €		
	LS	- - €	- - €	- - €		
	PC	- - €	- - €	- - €		
	SK	- - €	- - €	- - €		
	HC	- - €	- - €	- - €		
RC	- - €	- - €	- - €			

035

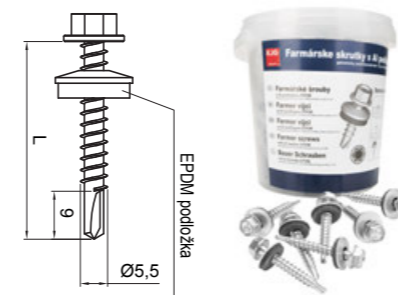

SM-GT12 – KJG POZINKOVANÁ SAMOVRTNÁ SKRUTKA

Menovitá veľkosť v mm	Balenie v ks		Objednávkové číslo	Cena s DPH
	250 ks	2000 ks		
5,5x35	250 ks	2000 ks	063571	0,108 €

036



SM-GT12 – KJG POZINKOVANÁ SAMOVRTNÁ SKRUTKA, FARBENÁ

Menovitá veľkosť v mm	5,5x35	
	Kýblik	Kartón
Obj. číslo / Cena	Kýblik	Cena s DPH
1. skupina farieb	TM	063694 0,132 €
	AN	063588 0,132 €
	IC	063625 0,132 €
	OC	063663 0,132 €
	MH	063632 0,132 €
	TH	- - €
	SB	063687 0,132 €
2. skupina farieb	BH	063601 0,132 €
	PS	063670 0,132 €
	BHT	063618 0,132 €
	MM	- - €
	MZ	063656 0,132 €
	MOT	063649 0,132 €
	TZ	- - €
3. skupina farieb	B	063595 0,132 €
	LS	- - €
	PC	- - €
	SK	- - €
	HC	- - €
RC	- - €	

037



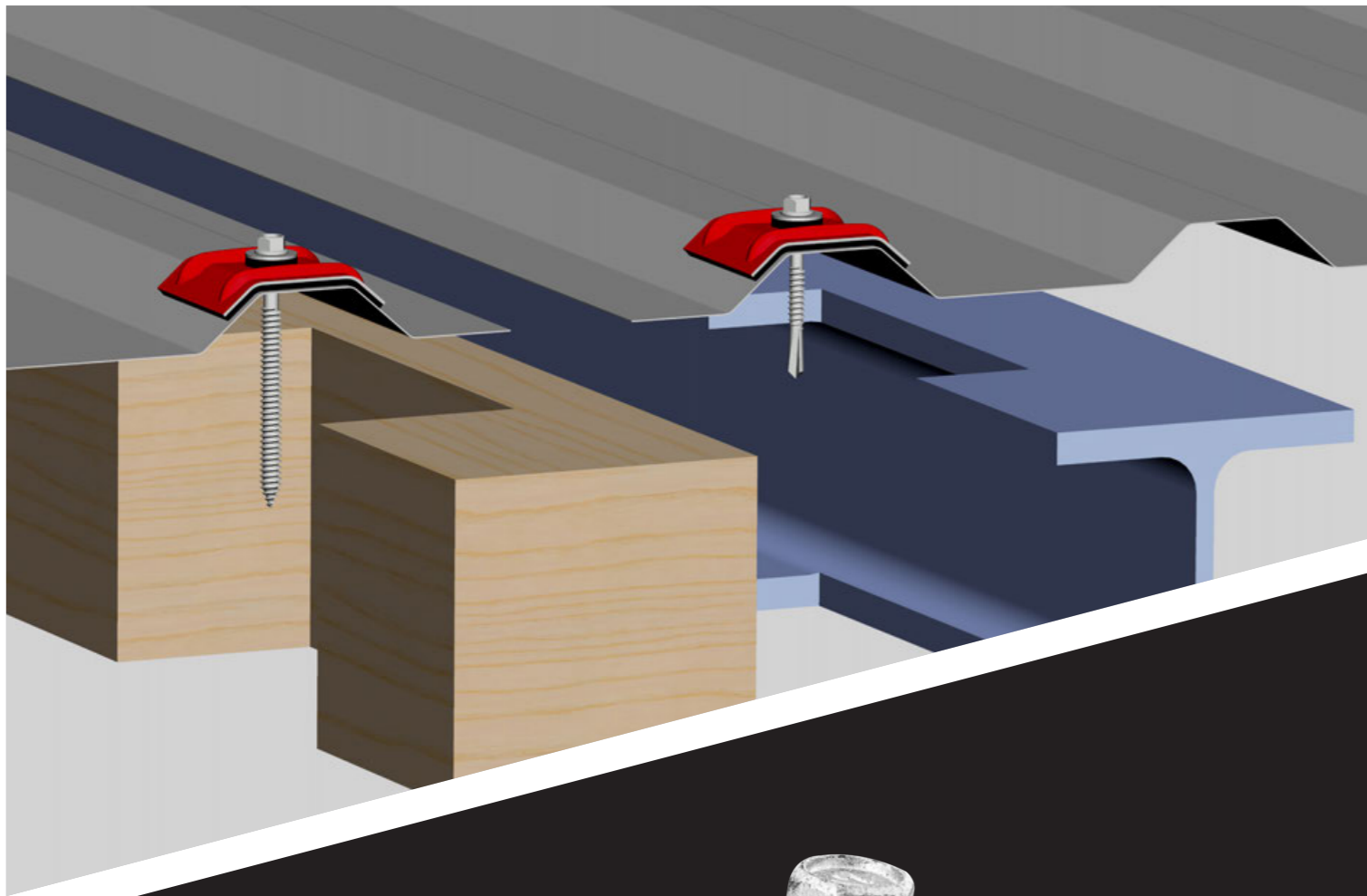

SM – KALOTA ORKAN PRE TRAPÉZ TR 18 ALUZINK

Menovitá veľkosť v mm	Balenie v ks		Objednávkové číslo	Cena s DPH
35/50	100 ks	-	064233	0,360 €

038

SM – KALOTA ORKAN PRE TRAPÉZ TR 18 FARBENÁ

Menovitá veľkosť v mm	34/50		Obj. číslo / Cena	Cena s DPH
	Kýblik	Kartón		
1. skupina farieb				
TM		100 ks	064301	0,396 €
AN		-	064240	0,396 €
IC		-	-	- €
OC		-	064288	0,396 €
MH		-	064271	0,396 €
TH		-	-	- €
2. skupina farieb				
SB		-	064295	0,396 €
BH		-	064264	0,396 €
PS		-	-	- €
BHT		-	064318	0,396 €
MM		-	-	- €
MZ		-	-	- €
MOT		-	-	- €
TZ		-	-	- €
3. skupina farieb				
B		-	064257	0,396 €
LS		-	-	- €
PC		-	-	- €
SK		-	-	- €
HC		-	-	- €
RC		-	-	- €

039

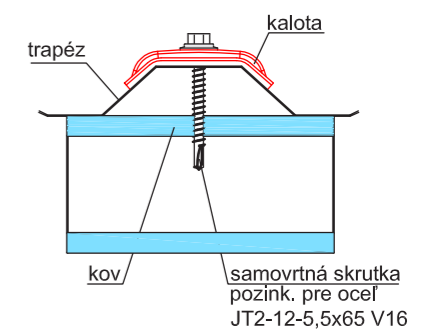
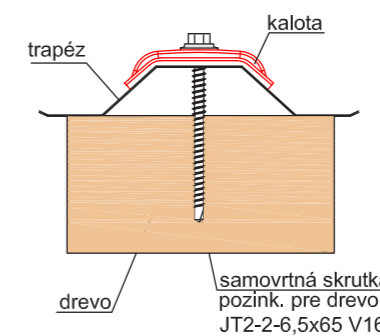
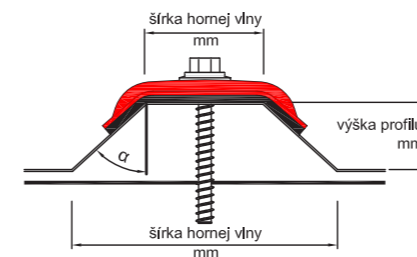



SM – KALOTA ORKAN PRE TRAPÉZ TR 35 ALUZINK

Menovitá veľkosť v mm	Balenie v ks		Objednávkové číslo	Cena s DPH
41/39	100 ks	-	064226	0,40 €

040

SM – KALOTA ORKAN PRE TRAPÉZ TR 35 FARBENÁ

Menovitá veľkosť v mm	41/39		Objednávkové číslo	Cena s DPH
Balenie v ks				
Kýblik	Kartón	100 ks	-	
Obj. číslo / Cena		Cena s DPH		
1. skupina farieb	TM	064196	0,43 €	
	AN	064110	0,43 €	
	IC	064141	0,43 €	
	OC	064165	0,43 €	
	MH	064158	0,43 €	
	TH	-	- €	
2. skupina farieb	SB	064189	0,43 €	
	BH	064134	0,43 €	
	PS	064172	0,43 €	
	BHT	064202	0,43 €	
	MM	-	- €	
	MZ	-	- €	
	MOT	064219	0,43 €	
	TZ	-	- €	
3. skupina farieb	B	064127	0,43 €	
	LS	-	- €	
	PC	-	- €	
	SK	-	- €	
	RC	-	- €	

041

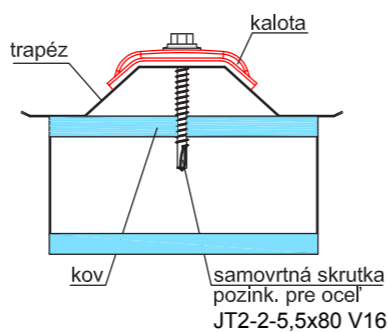
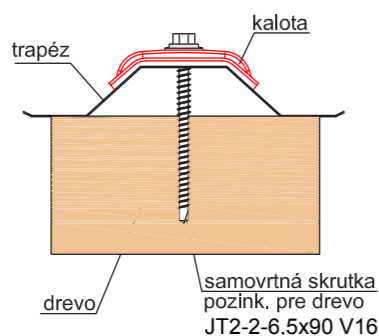
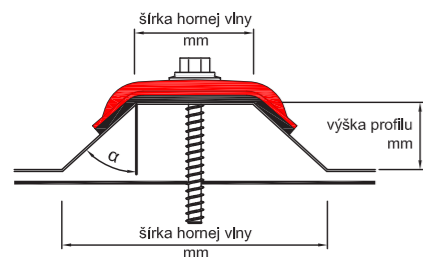

SM – SAMOVRTNÁ SKRUTKA POZINKOVANÁ-OCEĽ PRE TR 18 A TR 35

Menovitá veľkosť v mm	Balenie v ks		Objednávkové číslo	Cena s DPH
TR 18-5,5x65 V16	100 ks	-	064677	- €
TR 35-5,5x80 V16	100 ks	-	-	- €

042



SM – SAMOVRTNÁ SKRUTKA POZINKOVANÁ-DREVO PRE TR 18 A TR 35

Menovitá veľkosť v mm	Balenie v ks		Objednávkové číslo	Cena s DPH
TR 18-6,5x65 V16	100 ks	-	064684	- €
TR 35-6,5x90 V16	100 ks	-	064691	- €

043



SM – TANIEROVÁ PODLOŽKA HTV-TK 82/40

Menovitá veľkosť mm	Balenie v ks		Objednávkové číslo	Cena s DPH/ks
HTV-TK 82/40	100 ks	500 ks	064103	0,14 €

044



SM – POZINKOVANÁ SKRUTKA DABO PRE HTV-TK 82/40

Menovitá veľkosť mm	Balenie v ks		Objednávkové číslo	Cena s DPH/ks
4,8 x 35	500 ks	-	064509	0,06 €

045

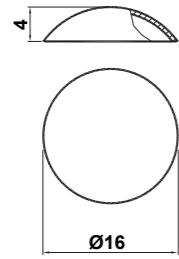
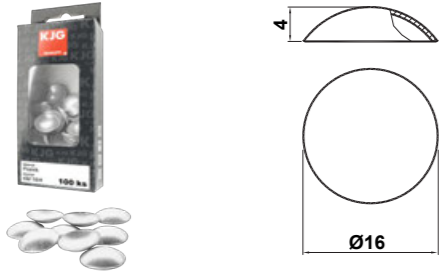

SM-KM – KRYTKA MONTÁŽNA POZINKOVANÁ

Menovitá veľkosť v mm	Balenie v ks		Objednávkové číslo	Cena s DPH/balenie
KM 16/4	100 ks	-	007131	6,24 €

046

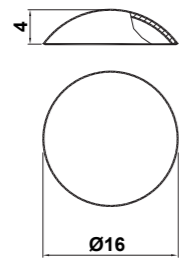
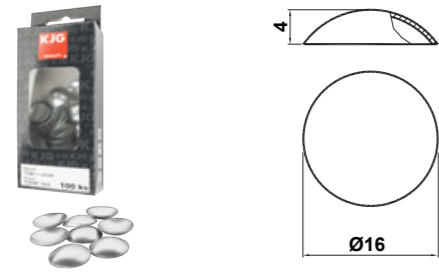

SM-TZKM – KRYTKA MONTÁŽNA TITÁN-ZINKOVÁ

Menovitá veľkosť v mm	Balenie v ks		Objednávkové číslo	Cena s DPH/balenie
TZKM 16/4	100 ks	-	007292	12,00 €

047

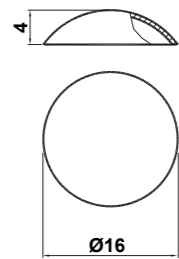
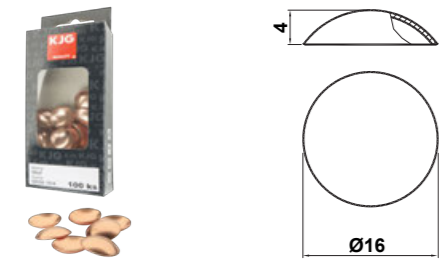

SM-MKM – KRYTKA MONTÁŽNA MEDENÁ

Menovitá veľkosť v mm	Balenie v ks		Objednávkové číslo	Cena s DPH/balenie
MKM 16/4	100 ks	-	007285	14,40 €

048

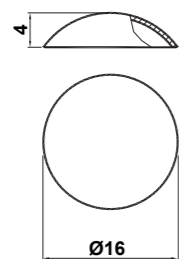
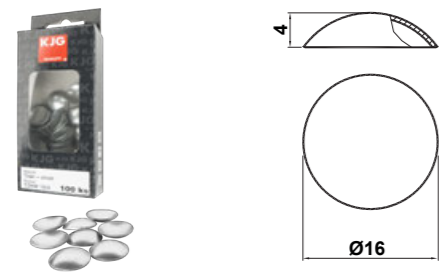

SM-HKM – KRYTKA MONTÁŽNA HLINÍKOVÁ

Menovitá veľkosť v mm	Balenie v ks		Objednávkové číslo	Cena s DPH/balenie
HKM 16/4	100 ks	-	063205	12,00 €

049

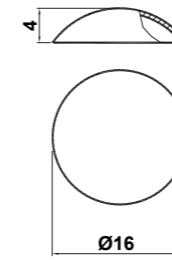

SM-KM – KRYTKA MONTÁŽNA POZINK FARBENÝ

Menovitá veľkosť v mm	KM 16/4		Obj. číslo / Cena	Cena s DPH/bal
Balenie v ks	100	-		
Balenie	-	100		

Obj. číslo / Cena	1. skupina farieb		Obj. číslo / Cena	Cena s DPH/bal
TM	007261	8,40 €		
AN	007148	8,40 €		
IC	007186	8,40 €		
OC	007230	8,40 €		
MH	007193	8,40 €		
SB	007254	8,40 €		
PS	007247	8,40 €		
BH	007162	8,40 €		
BHT	007179	8,40 €		
B	007155	8,40 €		
MM	007209	8,40 €		
MZ	007223	8,40 €		
MOT	007216	8,40 €		
TZ	007278	8,40 €		

050

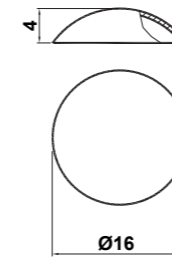

SM-HKM – KRYTKA MONTÁŽNA HLINÍK FARBENÝ

Menovitá veľkosť v mm	HKM 16/4		Obj. číslo / Cena	Cena s DPH/bal
Balenie v ks	100	-		
Balenie	-	100		

Obj. číslo / Cena	1. skupina farieb		Obj. číslo / Cena	Cena s DPH/bal
AN	063212	12,00 €		
TM	063250	12,00 €		
SS	063243	12,00 €		
ZH	-	- €		
MH	-	- €		
BH	-	- €		
IC	063236	12,00 €		
OC	-	- €		
MZ	-	- €		
B	063229	12,00 €		
ZS	-	- €		
BHT	-	- €		
HM	-	- €		
OZ	-	- €		

051



NPRP – NEREZOVÁ PRÍPONKA PEVNÁ

Menovitá veľkosť v mm	Balenie v ks		Objednávkové číslo	Cena s DPH
NPRP 25	500 ks	40.000 ks	001238	0,114 €
NPRP 28	500 ks	40.000 ks	001245	0,120 €
NPRP 32	500 ks	40.000 ks	001252	0,144 €

052



NPRPO – NEREZOVÁ PRÍPONKA POSUVNÁ 55

Menovitá veľkosť v mm	Balenie v ks		Objednávkové číslo	Cena s DPH
NPRPO 25 / 55	500 ks	20.000 ks	001276	0,228 €
NPRPO 28 / 55	500 ks	20.000 ks	001290	0,288 €
NPRPO 32 / 55	500 ks	20.000 ks	001313	0,300 €

053



NPRPO – NEREZOVÁ PRÍPONKA POSUVNÁ 70

Menovitá veľkosť v mm	Balenie v ks		Objednávkové číslo	Cena s DPH
NPRPO 25 / 70	400 ks	–	001283	0,672 €
NPRPO 28 / 70	400 ks	–	001306	0,828 €
NPRPO 32 / 70	400 ks	–	001320	0,900 €

054



NPRN – NEREZOVÁ PRÍPONKA NOHAVICOVÁ

Menovitá veľkosť v mm	Balenie v ks		Objednávkové číslo	Cena s DPH
NPRN	100 ks	–	001214	0,240 €

055



NPRNPO – NEREZOVÁ PRÍPONKA NOHAVICOVÁ POSUVNÁ

Menovitá veľkosť v mm	Balenie v ks		Objednávkové číslo	Cena s DPH
NPRNPO	100 ks	–	001221	0,720 €

056